



Atlas Copco



Service Offer Handheld Tools

We offer you peace of mind with our extensive accessories and consumables portfolio for your handheld equipment.

Working Tools

Tools for every job

Working tools are manufactured from low carbon steel. It combines the benefits of case hardened skin without risk of core brittleness.

The strike face is end milled. True contact between the piston and the striking end transmits the maximum blow energy to the workplace. Vibration and wear on both hammer and tool are minimized.











Forged under traditional hammers, our tools allow the most beneficial grain flows for durable strength.

Passing electronically controlled bed furnaces, the tools are processed in a chamber of molten aluminium oxide to prevent airborne contaminants.

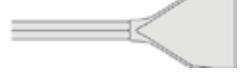
After heat treatment all tools are cleaned by inducing a positive stress into the skin. Finally they are lacquer coated for maximum protection and attractive presentation.

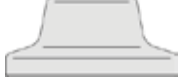
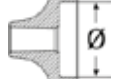

Application Guide

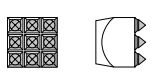
	Working tool	Application								Comments
		breaking ¹⁾	cutting ¹⁾	digging	tie tamping	compacting	rod driving	splitting	re-dressing	
	Moil point	●	-	-	-	-	-	-	-	Breaking in concrete and soft materials (no line of fracture) making holes in hard materials
	Narrow chisel	●	-	-	-	-	-	-	-	Concrete and soft material general-purpose tool that controls the line of fracture
	Wedge chisel	●	-	-	-	-	-	-	-	Concrete and frozen ground a heavy-duty tool giving a progressive wedging force
	Wide chisel	-	●	-	-	-	-	-	-	Suitable for medium hard to hard asphalt
	Asphalt cutter	-	●	-	-	-	-	-	-	Hot rolled asphalt, gives a straight and clean cutting edge
	Digging spade	-	●	●	-	-	-	-	-	Cutting asphalt or loosen material prior to excavation
	Digging chisel	-	-	●	-	-	-	-	-	Loosen material prior to excavation where the ground conditions are difficult
	Clay spade	-	●	●	-	-	-	-	-	Heavy dense clay or frozen ground, the scooped, curved profile gives efficient cutting
	Tie tamper	-	-	-	●	-	-	-	-	Compaction of ballast under railway sleepers (ties)
	Tamping pad	-	-	-	-	●	-	-	-	Consolidation of sub base back fill and asphalt patching
	Driver	-	-	-	-	-	●	-	-	Driving rods stakes etc. into the ground
	Wedge plug & feather	-	-	-	-	-	-	●	-	Rock splitting for (pre-drilled) hole diameter 29 mm (1 1/8 in), alternatively 34 mm (1 3/8 in)
	Bush hammer	-	-	-	-	-	-	-	●	Re-dressing of concrete or natural stone









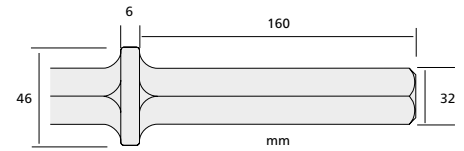





¹⁾ Use as wide tool as the material allows to make the job quicker

¹⁾ 1 kg = 2.2 lb

Shank Hex 32 x 160 mm (Hex 1¼ x 6¼ in)

point to flat (ISO) 



	Description	Working length		Total length		Blade / Tip width		Weight	Part number
		mm	in	mm	in	mm	in	kg ¹⁾	
	Moil point	380	15	545	21	-	-	3.5	3083 3205 00
		450	18	615	24	-	-	4.0	3083 3206 00
		1000	39	1165	46	-	-	7.6	3083 3207 00
	Narrow chisel	380	15	545	21	-	-	3.5	3083 3208 00
		450	18	615	24	-	-	4.0	3083 3209 00
		1000	39	1165	46	-	-	7.6	3083 3210 00
	Wide chisel	380	15	545	21	75	3	3.7	3083 3211 00
	Asphalt cutter	300	12	465	18	115	4 ½	3.8	3083 3212 00
	Digging chisel	380	15	545	21	75	3	4.4	3083 3213 00
	Digging spade	380	15	545	21	125	5	5.1	3083 3214 00
	Clay spade	380	15	545	21	140	5 ½	5.4	3083 3215 00
	Wedge chisel	400	16	565	22	40	1 ½	4.1	3083 3216 00
	Tie tamper	400	16	565	22	100	4	4.9	3083 3217 00
		580	23	745	29	100	4	6.2	3083 3217 10
	Spiking tool	195	7 ¾	360	14	-	-	4.6	9245 2826 81
	Shaft for pad	235	9 ¼	400	16	-	-	3.2	3083 3218 01
	Tamping pad	-	-	-	-	Ø180	Ø7	7.2	3083 3301 00
		-	-	-	-	□150	□6	8.3	3083 3302 00
		-	-	-	-	□200	□8	8.5	3083 3197 00
	Driver blank	-	-	-	-	Ø80	Ø3	3.5	9245 2827 10
	Driver Pad	-	-	-	-	Ø120	Ø5	6.0	3376 1120 79
		-	-	-	-	Ø150	Ø6	7.0	3376 1120 77



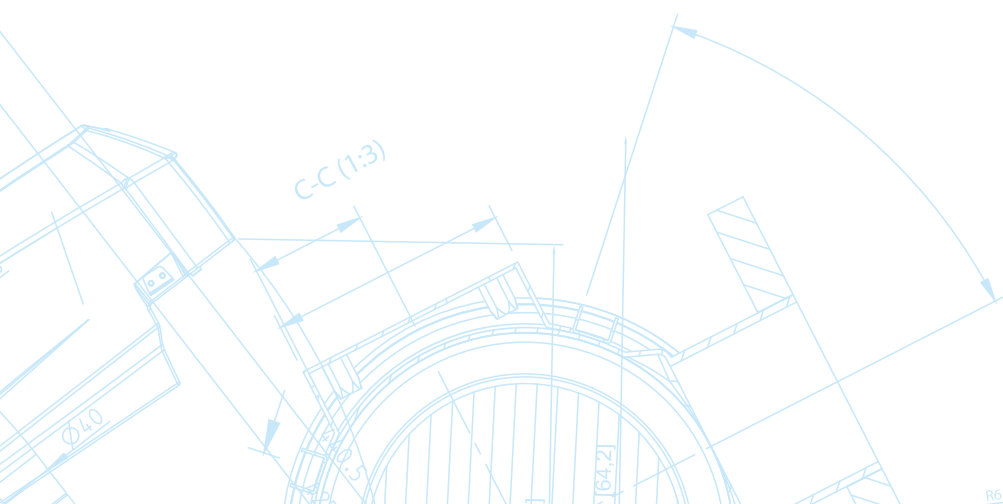





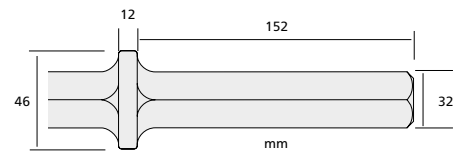

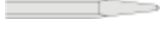
¹⁾ 1 kg = 2.2 lb



Shank Hex 32 x 152 mm (Hex 1¼ x 6 in)

flat to flat (North America) 

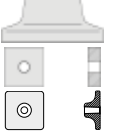









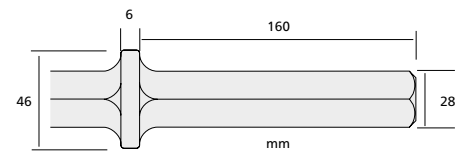





	Description	Working length		Total length		Blade / Tip width		Weight	Part number
		mm	in	mm	in	mm	in	kg ¹⁾	
	Moil point	355	14	520	20	-	-	3.3	3083 3285 00
		450	18	615	24	-	-	4.0	3083 4000 10
		610	24	775	30	-	-	5.0	3083 4000 20
	Narrow chisel	355	14	520	20	-	-	3.3	3083 3286 00
		450	18	615	24	-	-	4.0	3083 4001 10
		610	24	775	30	-	-	5.0	3083 4001 20
	Wide chisel	380	15	545	21	75	3	3.6	3083 3295 00
	Asphalt cutter	330	13	495	19	125	5	4.0	3083 3096 00
		305	12	470	19	115	4 ½	4.0	3083 4004 00
	Digging spade	320	13	485	19	125	5	4.3	3083 3298 00
	Clay spade	380	15	545	21	140	5 ½	5.4	3083 3299 00
	Tie tamper	400	16	565	22	100	4	5.0	3083 3314 00
	Shaft for pad	230	9	395	16	-	-	3.1	3083 3287 00
	Tamping pad	-	-	-	-	Ø180	Ø7	7.2	3083 3301 00
		-	-	-	-	□150	□6	8.3	3083 3302 00
		-	-	-	-	□200	□8	8.5	3083 3197 00
	Driver blank	-	-	-	-	Ø80	Ø3	3.5	9245 2827 10
	Driver Pad	-	-	-	-	Ø120	Ø5	6.0	3376 1120 79
		-	-	-	-	Ø150	Ø6	7.0	3376 1120 77

¹⁾ 1 kg = 2.2 lb

Shank Hex 28 x 160 mm (Hex 1 1/8 x 6 1/4 in)

point to flat (ISO) 



	Description	Working length		Total length		Blade / Tip width		Weight kg ¹⁾	Part number
		mm	in	mm	in	mm	in		
	Moil point	380	15	545	21	-	-	2.8	3083 3271 00
		450	18	615	24	-	-	3.3	3083 3272 00
		1000	39	1165	46	-	-	6.3	3083 3273 00
	Narrow chisel	380	15	545	21	-	-	2.8	3083 3274 00
		450	18	615	24	-	-	3.3	3083 3275 00
		1000	39	1165	46	-	-	6.3	3083 3276 00
	Wide chisel	380	15	545	21	75	3	3.1	3083 3277 00
	Asphalt cutter	300	12	465	18	115	4 1/2	3.6	3083 3278 00
	Digging chisel	380	15	545	21	75	3	4	3083 3279 00
	Digging spade	380	15	545	21	125	5	4.7	3083 3280 00
	Clay spade	380	15	545	21	140	5 1/2	5.4	3083 3281 00
	Wedge chisel	400	16	565	22	40	1 1/2	3.9	3083 3282 00
	Tie tamper	400	16	565	22	100	4	4.3	3083 3319 00
	Shaft for pad	230	9	395	16			2.8	3083 3283 01
	Tamping pad	-	-	-	-	Ø180	Ø7	7.2	3083 3301 00
		-	-	-	-	□150	□6	8.3	3083 3302 00
		-	-	-	-	□200	□8	8.5	3083 3197 00
	Driver blank	-	-	-	-	Ø80	Ø3	3.5	9245 2827 10
	Driver Pad	-	-	-	-	Ø120	Ø5	6.0	3376 1120 79
		-	-	-	-	Ø150	Ø6	7.0	3376 1120 77



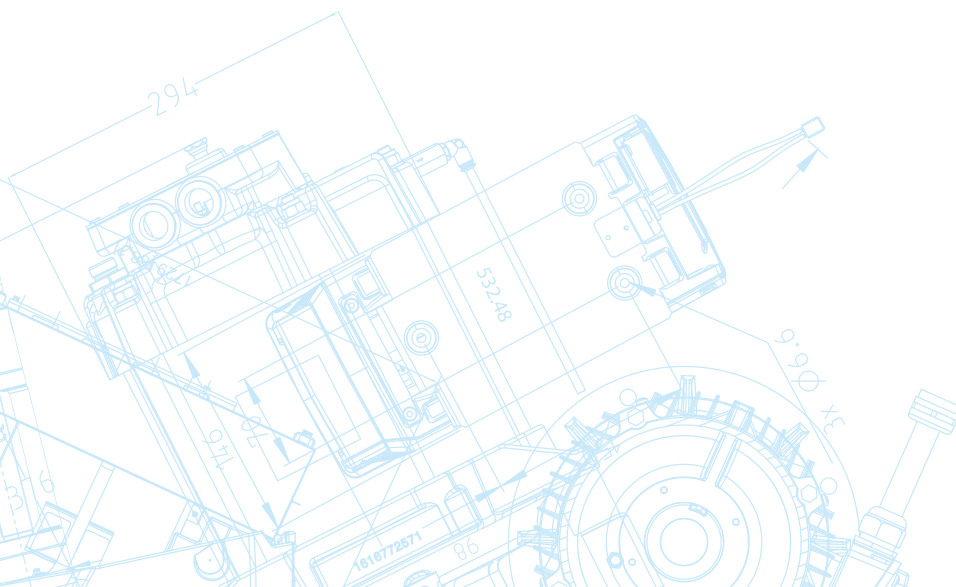





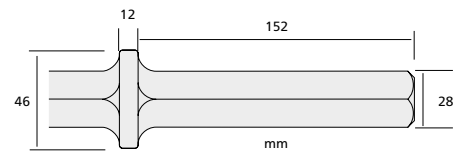



¹⁾ 1 kg = 2.2 lb

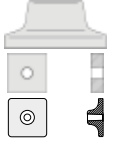

Shank Hex 28 x 152 mm (Hex 1 1/8 x 6 in)

flat to flat (North America) 











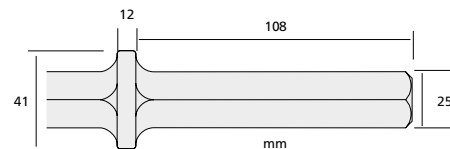



	Description	Working length		Total length		Blade / Tip width		Weight	Part number
		mm	in	mm	in	mm	in	kg ¹⁾	
	Moil point	350	14	515	20	-	-	2.6	3083 3267 00
		450	18	615	24	-	-	3.3	3083 4015 10
		610	24	775	30	-	-	4.1	3083 4015 20
	Narrow chisel	350	14	515	20	-	-	2.6	3083 3268 00
		450	18	615	24	-	-	3.3	3083 4016 10
		610	24	775	30	-	-	4.1	3083 4016 20
	Wide chisel	380	15	545	21	75	3	3.1	3083 3289 00
		450	18	615	24	75	3	3.6	3083 4017 00
	Asphalt cutter	280	11	445	18	115	4 1/2	3.6	3083 4019 00
	Digging chisel	380	15	545	21	75	3	4.2	3083 3291 00
	Digging spade	320	13	485	19	125	5	3.8	3083 3292 00
	Clay spade	380	15	545	21	140	5 1/2	5.0	3083 3293 00
	Shaft for pad	230	9	395	16	-	-	2.8	3083 3269 00
	Tamping pad	-	-	-	-	Ø180	Ø7	7.2	3083 3301 00
		-	-	-	-	□150	□6	8.3	3083 3302 00
		-	-	-	-	□200	□8	8.5	3083 3197 00
	Driver blank	-	-	-	-	Ø80	Ø3	3.5	9245 2827 10
	Tie Tamper	400	15.7	562	22	100	4	4.2	3083 4020 10
	Driver Pad	-	-	-	-	Ø120	Ø5	6.0	3376 1120 79
		-	-	-	-	Ø150	Ø6	7.0	3376 1120 77

¹⁾ 1 kg = 2.2 lb

Shank Hex 25 x 108 mm (Hex 1 x 4¼ in)

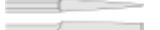
point to flat (ISO) 









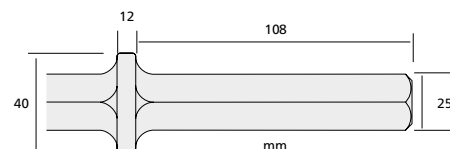



	Description	Working length		Total length		Blade / Tip width		Weight kg ¹⁾	Part number
		mm	in	mm	in	mm	in		
	Moil point	380	15	500	20	-	-	2.1	3083 3253 00
	Narrow chisel	380	15	500	20	-	-	2.1	3083 3254 00
	Wide chisel	380	15	500	20	75	3	2.5	3083 3255 00
	Digging chisel	380	15	500	20	75	3	3.2	3083 3256 00
	Digging spade	380	15	500	20	120	3 ¾	3.9	3083 3257 00
	Clay spade	430	17	550	22	125	5	3.3	3083 3033 00
	Wedge chisel	380	15	500	20	35	1 ¾	2.4	3083 3258 00
	Shaft for pad	280	11	400	16	-	-	1.9	3083 3259 00
	Tamping pad	-	-	-	-	Ø175	Ø7	7.5	3083 3252 10
	Tamping pad square	-	-	-	-	□175	□7	6.0	3083 3239 01
	Driver pad	-	-	-	-	Ø65	Ø2 ½	3.0	3371 8060 39
		-	-	-	-	Ø100	Ø5	4	9245 2817 90

Shank Hex 25 x 108 mm (Hex 1 x 4¼ in)

flat to flat (North America) 







	Description	Working length		Total length		Blade / Tip width		Weight kg ¹⁾	Part number
		mm	in	mm	in	mm	in		
	Moil point	380	15	500	20	-	-	2.1	3083 4030 00
		450	18	570	22	-	-	2.5	3083 4030 10
		610	24	730	29	-	-	3.1	3083 4030 20
	Narrow chisel	380	15	500	20	-	-	2.1	3083 3309 00
		450	18	570	22	-	-	2.5	3083 4031 10
		610	24	730	29	-	-	3.1	3083 4031 20
	Wide chisel	380	15	500	20	75	3	2.5	3083 3310 00
		380	15	500	20	40	1½	2.4	3083331300
	Asphalt cutter	330	13	450	18	125	5	2.9	3083 4033 00
	Digging spade	330	13	450	18	120	4 ¾	4.0	3083 3312 00
	Clay spade	410	16	530	21	125	5	3.8	3083 4035 00
	Shaft for pad	280	11	400	16	-	-	2.0	3083 4037 00
	Tamping pad	-	-	-	-	Ø175	Ø7	7.5	3083 3252 10
		-	-	-	-	□175	□7	6.0	3083 3239 01
	Driver pad	-	-	-	-	Ø65	Ø2 ½	2.5	3371 8060 39
		-	-	-	-	Ø100	Ø4	2.5	9245 2817 90
	Tie tamper	450	18	570	23	90	3.5	4.4	3083 3320 00

¹⁾ 1 kg = 2.2 lb

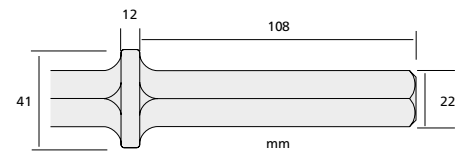
Shank Hex 22 x 108 mm (Hex 7/8 x 4 1/4 in)

point to flat 



	Description	Working length		Total length		Blade / Tip width		Weight	Part number
		mm	in	mm	in	mm	in	kg ¹⁾	
	Moil point	350	14	470	19	-	-	1.5	3083 3228 00
		480	19	600	24	-	-	2.0	3083 3229 00
	Narrow chisel	240	9 1/2	360	14	45	1 3/4	1.2	3083 3231 00
		340	13	460	18	28	1 3/4	1.4	3083 3230 00
		450	18	570	22	23	1 3/4	2.0	3083 4071 00
	Wide chisel	380	15	500	20	75	3	2.6	3083 3232 00
		450	18	570	22	75	3	3.1	3083 4072 00
	Asphalt cutter	350	14	470	19	125	5	3.0	9245 2812 90
	Digging chisel	280	11	400	16	75	3	2.7	3083 3233 00
	Digging spade	330	13	450	18	120	4 3/4	3.2	3083 3234 00
	Clay spade	350	14	470	19	125	5	3.4	3083 3235 00
	Wedge chisel	380	15	500	20	35	1 3/8	2.8	3083 3236 00
	Tie tamper	390	15	510	20	90	3 1/2	3.0	3083 3237 00
	Tie tamper	460	18	580	23	90	3 1/2	3.3	9245 2823 30
	Wedge hammer	195	7 3/4	315	12	Ø 42	Ø 1 5/8	2.0	3083 3241 00
	Driver blank	195	7 3/4	315	12	Ø 55	Ø 2 1/8	2.5	9245 2822 80
	Shaft for pad	185	7 1/4	305	12	-	-	1.3	3083 3238 00
	Tamping pad	-	-	-	-	Ø 175	Ø 7	7.5	3083 3252 10
		-	-	-	-	□175	□7	6.0	3083 3239 01
	Driver pad	-	-	-	-	Ø 65	Ø 2 1/2	-	3371 8060 39
		-	-	-	-	Ø 100	Ø 4	2.5	9245 2817 90
	Wedge plug ³⁾	-	-	390	15	20 x 24	3/4 x 1	0.9	9245 2822 00
	Feather pair ³⁾	-	-	180	7	Ø 26.5	Ø 1	0.6	9245 2822 10
	Wedge set ⁴⁾	-	-	-	-	-	-	1.5	9245 2813 81
	Wedge plug ⁵⁾	-	-	420	17	22 x 28	7/8 x 1 1/8	1.2	9245 2813 50
	Feather pair ⁵⁾	-	-	210	8 1/4	Ø 33	Ø 1 1/4	0.9	9245 2813 60
	Wedge set ⁶⁾	-	-	-	-	-	-	2.1	9245 2813 51

¹⁾ 1 kg = 2.2 lb

³⁾ for hole Ø 29 mm (1 1/8 in)

⁴⁾ for hole Ø 29 mm (1 1/8 in). 9245 2822 00 + 9245 2822 10

⁵⁾ for hole Ø 34 mm (1 3/8 in)







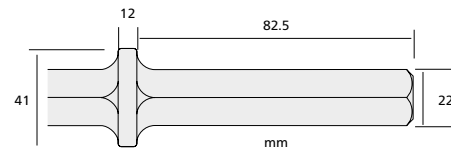

⁶⁾ for hole Ø 34 mm (1 3/8 in). 9245 2813 50 + 9245 2813 60

⁷⁾ 3082 3228 00 + 3083 3234 00 + 3083 3235 00 + 3083 3236 00

Shank Hex 22 x 82.5 mm (Hex 7/8 x 3 1/4 in)

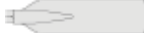
point to flat (ISO) 



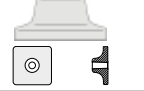
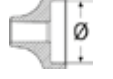





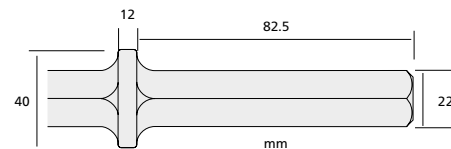

	Description	Working length		Total length		Blade / Tip width		Weight	Part number
		mm	in	mm	in	mm	in	kg ¹⁾	
	Moil point	380	15	475	19	-	-	1.5	3083 3242 00
		1000	39	1095	43	-	-	3.6	3083 3243 00
	Narrow chisel	380	15	475	19	-	-	1.5	3083 3244 00
		1000	39	1095	43	-	-	3.6	3083 3245 00
	Wide chisel	380	15	475	19	75	3	2.3	3083 3246 00
	Asphalt cutter	380	15	475	19	125	5	3.2	3083 3069 00
	Digging chisel	450	18	545	21	75	3	3.5	3083 3247 00
	Digging spade	400	16	495	19	120	4 3/4	3.7	3083 3248 00
	Clay spade	430	17	525	21	125	5	3.3	3083 3249 00
	Wedge chisel	380	15	475	19	35	1 3/8	2.6	3083 3250 00
	Shaft for pad	310	12	405	16	-	-	1.3	3083 3251 00
	Tamping pad	-	-	-	-	Ø175	Ø 7	7.5	3083 3252 10
		-	-	-	-	□175	□ 7	6.0	3083 3239 01
	Driver pad	-	-	-	-	Ø 65	Ø2 1/2	2.5	3371 8060 39
		-	-	-	-	Ø100	Ø 4	2.5	9245 2817 90

Shank Hex 22 x 82.5 mm (Hex 7/8 x 3 1/4 in)

flat to flat (North America) 

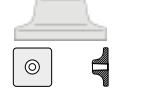





	Description	Working length		Total length		Blade / Tip width		Weight	Part number
		mm	in	mm	in	mm	in	kg ¹⁾	
	Moil point	355	14	450	18	-	-	1.5	3083 4050 00
		450	18	545	21	-	-	1.8	3083 4050 10
		610	24	705	28	-	-	2.3	3083 4050 20
	Narrow chisel	355	14	450	18	-	-	1.5	3083 3303 00
		450	18	545	21	-	-	1.8	3083 4051 10
		610	24	705	28	-	-	2.3	3083 3304 00
	Wide chisel	355	14	450	18	75	3	1.8	3083 3305 00
	Digging chisel	355	14	450	18	75	3	3.2	3083 3306 00
	Clay spade	430	17	525	21	125	5	3.6	3083 3308 00
	Shaft for pad	205	8	300	12	-	-	1.1	3083 4058 00
	Tamping pad	-	-	-	-	Ø175	Ø 7	7.5	3083 3252 10
		-	-	-	-	□175	□ 7	6	3083 3239 01
	Driver pad	-	-	-	-	Ø 65	Ø2 1/2	2.5	3371 8060 39
		-	-	-	-	Ø100	Ø 4	2.5	9245 2817 90

¹⁾ 1 kg = 2.2 lb

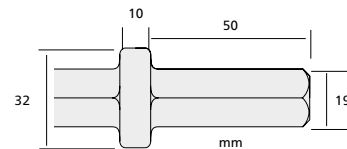
Shank Hex 19 x 50 mm (Hex ¾ x 2 in)

flat to flat 

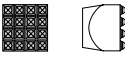

	Description	Working length		Total length		Blade / Tip width		Weight	Part number
		mm	in	mm	in	mm	in	kg ¹⁾	
	Moil point	240	9 ½	300	12	-	-	0.8	3083 3220 00
		440	17	500	20	-	-	1.3	3083 3221 00
		600	24	680	27	-	-	1.6	3310 1017 78
		1000	39	1060	42	-	-	2.8	3310 1017 79
	Narrow chisel	240	9 ½	300	12	-	-	0.8	3083 3222 00
		440	17	500	20	-	-	1.3	3083 3223 00
		600	24	660	26	-	-	1.6	3310 1017 71
		1000	39	1060	42	-	-	2.8	3310 1017 72
	Wide chisel	190	7 ½	250	10	60	2 ¾	0.7	3083 3224 00
	Shaft for bush hammer	80	3 ⅛	140	5 ½	-	-	0.4	3083 3225 00
	Bush hammer TC head	-	-	-	-	□40	□1 ½	0.5	3083 3226 00
		-	-	-	-	□40	□1 ½	0.5	3083 3227 00
	Bush hammer steel head	-	-	-	-	□32	□1 ¼	0.2	3083 4163 00

Shank Hex 14.7 mm (Hex .580 in)

(North America)  oval collar  round collar

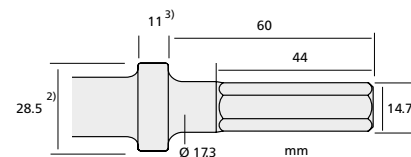



	Description	Working length		Total length		Blade / Tip width		Weight	Part number	
		mm	in	mm	in	mm	in		kg ¹⁾	oval collar
	Moil point	235	9 ¼	305	12	-	-	0.8	3083 4120 10	3083 4130 10
		380	15	450	18	-	-	1.1	3083 4120 20	3083 4130 20
	Narrow chisel	160	6 ¼	230	9	-	-	0.6	3083 4121 00	3083 4131 00
		235	9 ¼	305	12	-	-	0.8	3083 4121 10	3083 4131 10
	Wide chisel	380	15	450	18	38	1 ½	1.2	3083 4122 20	-
		380	15	450	18	65	2 ½	1.4	3083 4122 80	-
		160	6 ¼	230	9	75	3	0.7	3083 4122 90	-
	Bushing tool	170	6 ¾	240	9 ½	□50	□2	1.2	3083 4124 00	3083 4134 00
	Chisel blank	130	5	200	8	Ø 20	Ø ¾	0.5	3083 4125 00	-
		235	9 ¼	305	12	Ø 20	Ø ¾	0.7	3083 4125 10	-

¹⁾ 1 kg = 2.2 lb

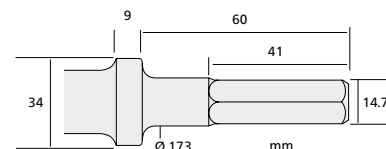
Shank Hex 14.7 – Rd 17.3 x 60 mm (Hex 5/16 – Rd 1 1/16 x 2 3/8 in)





	Description	Working length		Total length		Blade / Tip width		Weight kg ¹⁾	Part number
		mm	in	mm	in	mm	in		
	Moil point	230	9	300	12	-	-	0.7	3083 3200 00
	Wide chisel	175	7	245	10	60	2 3/8	0.7	3083 3410 00

Shank Rd 25 x 75 mm (Rd 1 x 3 in)

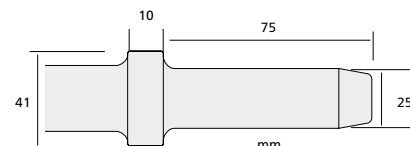

○ round collar

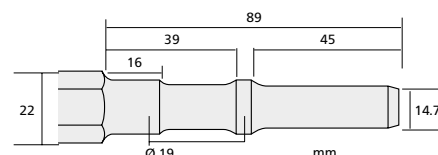

	Description	Working length		Total length		Blade / Tip width		Weight kg ¹⁾	Part number
		mm	in	mm	in	mm	in		
	Moil point	330	13	415	16	-	-	1.6	3083 3265 00
		450	18	535	21	-	-	2.0	3083 3265 10
		600	24	680	27	-	-	3.0	3310 1017 80
		800	31 1/2	880	35	-	-	3.9	3310 1017 81
		1200	47	1280	47	-	-	5.7	3310 1017 82
		1500	59	1580	59	-	-	7.1	3310 1017 83
		2000	79	2080	79	-	-	9.3	3310 1017 84
	Narrow chisel	330	13	415	16	-	-	1.6	3083 3266 00
		450	18	535	21	-	-	2.0	3083 3266 10
		600	24	680	27	-	-	3.0	3310 1017 73
		800	31 1/2	880	35	-	-	3.9	3310 1017 74
		1200	47	1280	47	-	-	5.7	3310 1017 75
		1500	59	1580	59	-	-	7.1	3310 1017 76
		2000	79	2080	79	-	-	9.3	3310 1017 77

Shank Rd 14.7 x 89 mm (Rd 5/16 x 3 1/2 in)



	Description	Working length		Total length		Blade / Tip width		Weight kg ¹⁾	Part number
		mm	in	mm	in	mm	in		
	Moil point	210	8 1/4	300	12	-	-	0.6	3083 3263 00
	Narrow chisel	210	8 1/4	300	12	-	-	0.6	3083 3264 00

¹⁾ 1 kg = 2.2 lb ²⁾ round collar: 31.5 ³⁾ round collar: 9.5

Shank Rd 19 x 95 mm (Rd ¾ x 3 ¾ in)

(North America)

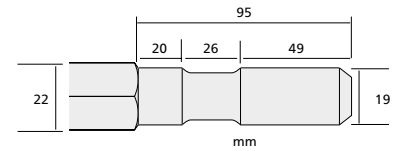

	Description	Working length		Total length		Blade / Tip width		Weight kg ¹⁾	Part number
		mm	in	mm	in	mm	in		
	Moil point	150	6	255	10	-	-	0.7	3083 4160 00
		275	11	380	15	-	-	1.0	3083 3261 00
	Narrow chisel	150	6	255	10	-	-	0.7	3083 4161 00
		275	11	380	15	-	-	1.0	3083 3262 00
	Wide chisel	150	6	255	10	75	3	0.8	3083 4165 00
	Shaft for bush hammer	125	5	380	9	-	-	0.6	3083 4162 00
	Bush hammer TC head	-	-	-	-	□40	□1 ½	0.5	3083 3226 00
		-	-	-	-	□40	□1 ½	0.5	3083 3227 00
	Bush hammer steel head	-	-	-	-	□32	□1 ¼	0.2	3083 4163 00

Shank Sq 19 x 82 mm (Sq ¾ x 3 ¼ in)

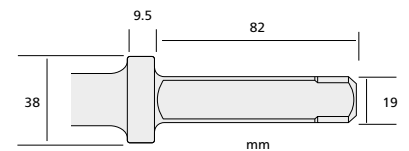

	Description	Working length		Total length		Blade / Tip width		Weight kg ¹⁾	Part number
		mm	in	mm	in	mm	in		
	Moil point	330	13	420	17	-	-	1.4	3083 4170 00
	Narrow chisel	330	13	420	17	-	-	1.4	3083 4170 10

Shank Rd 17.3 mm (Rd .680 in)

(North America)

oval collar

round collar

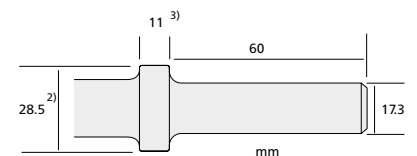





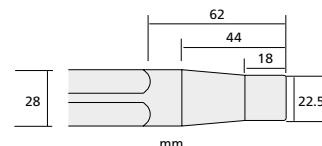

	Description	Working length		Total length		Blade / Tip width		Weight kg ¹⁾	Part number	
		mm	in	mm	in	mm	in		oval collar	round collar
	Moil point	160	6 ¼	230	9	-	-	0.6	3083 4100 00	3083 4110 00
		235	9 ¼	305	12	-	-	0.8	3083 4100 10	3083 4110 10
		380	15	450	18	-	-	1.1	3083 4100 20	3083 4110 20
	Narrow chisel	160	6 ¼	230	9	-	-	0.6	3083 4101 00	3083 4111 00
		235	9 ¼	305	12	-	-	0.8	3083 4101 10	3083 4111 10
		380	15	450	18	-	-	1.1	3083 4101 20	3083 4111 20
	Wide chisel	160	6 ¼	230	9	38	1 ½	0.7	3083 4102 00	-
		235	9 ¼	305	12	38	1 ½	0.9	3083 4102 10	-

¹⁾ 1 kg = 2.2 lb

Rivet Buster (Jumbo Shank Size)



	Description	Working length		Total length		Blade / Tip width		Weight kg ¹⁾	Part number
		mm	in	mm	in	mm	in		
	Moil point	145	5 ¾	255	10	-	-	0.9	3083 4140 00
		195	7 ¾	305	12	-	-	1.1	3083 4140 10
		340	13	450	18	-	-	1.8	3083 4140 20
	Narrow chisel	145	5 ¾	255	10	-	-	0.9	3083 4141 00
		195	7 ¾	305	12	-	-	1.1	3083 4141 10
		340	13	450	18	-	-	1.8	3083 4141 20
	Loose rivet buster	145	5 ¾	255	10	-	-	0.9	3083 4142 00
		195	7 ¾	305	12	-	-	1.1	3083 4142 10
		340	13	450	18	-	-	1.8	3083 4146 20
	Tight rivet buster	145	5 ¾	255	10	-	-	0.9	3083 4145 00
		195	7 ¾	305	12	-	-	1.1	3083 4145 10
		340	13	450	18	-	-	1.8	3083 4145 20
	Driftpin driver	80	3	190	7 ½	Ø 22	Ø 7/8	0.7	3083 4143 00
	Chisel ripper	120	4 ¾	230	9	-	-	0.8	3083 4144 00
	Backout punch - Long Clearance	102	4	212	8 ½	15.9	5/8	0.8	3083 4148 10
		152	6	262	10 ½	15.9	5/8	0.8	3083 4148 20
		102	4	212	8 ½	19	¾	0.8	3083 4148 40
		152	6	262	10 ½	19	¾	0.9	3083 4148 50
		102	4	212	8 ½	22	7/8	0.9	3083 4148 70
		152	6	262	10 ½	22	7/8	1.0	3083 4148 80

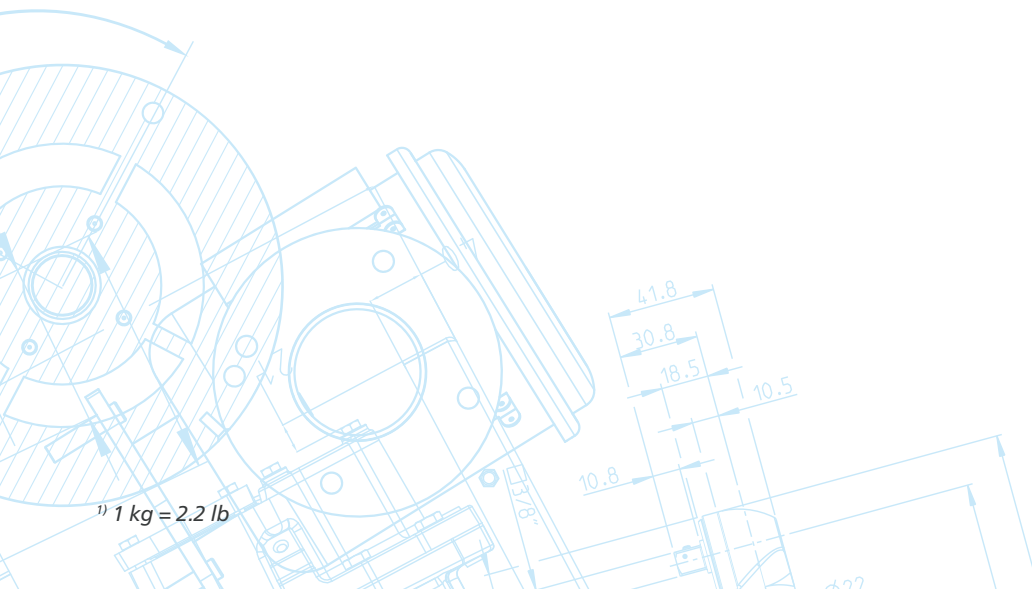

Shank Rd 19 x 95 mm (Rd ¾ x 3 ¾ in)

Plug hole drill

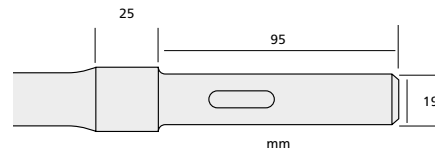

	Description	Working length		Total length		Blade / Tip width		Weight kg ¹⁾	Part number
		mm	in	mm	in	mm	in		
	Plug hole drill	200	8	330	13	Ø 13	Ø ½	0.4	3083 4150 00
		200	8	330	13	Ø 16	Ø 5/8	0.4	3083 4151 00
		300	12	430	17	Ø 16	Ø 5/8	0.5	3083 4151 10
		200	8	330	13	Ø 19	Ø ¾	0.5	3083 4152 00
		300	12	430	17	Ø 19	Ø ¾	0.6	3083 4152 10
		200	8	330	13	Ø 22	Ø 7/8	0.5	3083 4153 00
		300	12	430	17	Ø 22	Ø 7/8	0.9	3083 4153 10
		450	18	580	23	Ø 22	Ø 7/8	1.2	3083 4153 20
		200	8	330	13	Ø 25	Ø 1	0.6	3083 4154 00
		300	12	430	17	Ø 25	Ø 1	1	3083 4154 10
		450	18	580	23	Ø 25	Ø 1	1.3	3083 4154 20
Plug hole drill DKR-36R	265	10	395	16	Ø 13	Ø ½	0.5	3083 4150 10	
	450	18	580	23	Ø 16	Ø 5/8	0.8	3083 4151 20	
	450	18	580	23	Ø 19	Ø ¾	0.9	3083 4152 20	
Adaptor CP 9 to SDS Plus								R137586	

Shank Rd 19 - Hex 14.7 x 89 mm (Rd ¾ - Hex 5/16 x 3 ½ in)

Plug hole drill

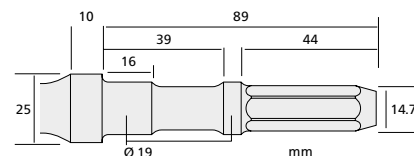

	Description	Working length		Total length		Blade / Tip width		Weight kg ¹⁾	Part number
		mm	in	mm	in	mm	in		
	Plug hole drill ²⁾	80	3	110	4 ¼	Ø 8	Ø 5/16	0.02	0701 0808 00
		100	4	130	5	Ø 10	Ø 13/32	0.04	0701 1010 00
		120	4 ¾	150	6	Ø 12	Ø ½	0.08	0701 1212 00
	Plug hole drill	150	6	250	10	Ø 16	Ø 5/8	0.4	0700 1416 32
		230	9	330	13	Ø 19	Ø ¾	0.5	0700 2019 32
		230	9	330	13	Ø 22	Ø 7/8	0.6	0700 2022 32
		230	9	330	13	Ø 25	Ø 1	0.7	0700 2025 32
		330	13	430	17	Ø 32	Ø 1 ¼	1.0	0700 3032 32
		330	13	430	17	Ø 32	Ø 1 ¼	1.4	0700 3038 32
	Shank adapter ³⁾	-	-	125	5	-	-	0.2	0701 1001 32
	Knock-out block ^{2) 3)}	-	-	-	-	-	-	0.8	3085 0210 00
	Moil Point DKR-36	210	8 ¼	300	12	-	-	0.6	3083 3263 00
	Narrow Chisel DKR-36	210	8 ¼	300	12	-	-	0.6	3083 3264 00

¹⁾ 1 kg = 2.2 lb ²⁾ Use with shank adaptor 0701 1001 32 ³⁾ For 8 mm, 10 mm and 12 mm drills

Drilling rods and bits



Whatever the **handheld application**, we have the solutions to match! **Our new product range is covering all the diameters and the lengths that our handheld drillers can drill.** The lowest cost per meter drilled is our guiding principle at Atlas Copco for our **handheld drilling** machines. Hence we use super tough C253 steel in our Atlas Copco integral drill rods. Our manufacturing process complements the quality of the raw material. Inserts are subjected to a high-quality bronze-brazing process using the exact right temperature and technique to reduce the risk of carbide failure. The shank is hardened to ensure the highest possible toughness and wear resistance.

To meet diverse demands, we supply hexagonal rods 19 mm, 22 mm and 25 mm in a wide variety of lengths and great quality of bits fitting to them. Thanks to our global presence, we're never more than a phone call away.

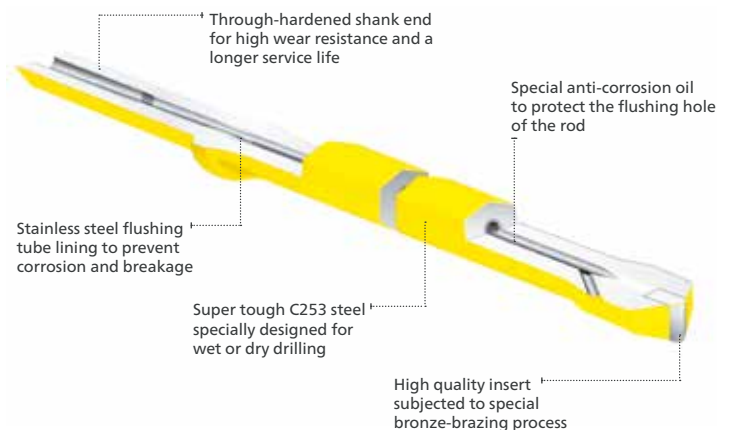

22 mm (7/8") Chisel bit integral.
Rod hex. 22 mm (7/8") Shank hex. 22 mm (7/8") x 108 mm (4 1/4")



Description	Length (L)		Bit diameter		Weight approx.	Part number
	mm	ft/in	mm	in	kg	
	400	1'3 3/4"	41	1 5/8	1.8	3310 1017 25
	600	1'11 5/8"	41	1 5/8	2.4	3310 1016 76
	800	2'7 1/2"	40	1 9/16	3.0	3310 1016 77
	800	2'7 1/2"	38	1 1/2	3.1	3310 1017 28
	1200	3'11 1/4"	40	1 9/16	4.3	3310 1016 78
	1200	3'11 1/4"	39	1 17/32	4.3	3310 1017 26
	1600	5'3"	39	1 17/32	5.4	3310 1016 79
	1600	5'3"	36	1 3/32	5.5	3310 1017 30
	1800	5'10 7/8"	39	1 17/32	6.1	3310 1016 80
	1800	5'10 7/8"	36	1 3/32	6.0	3310 1017 31
	2400	7'10 1/2"	38	1 1/2	7.8	3310 1016 81
	3200	10'6"	37	1 5/32	10.3	3310 1016 82
	4000	13'1 1/2"	36	1 3/32	12.6	3310 1017 29
	4800	15'9"	35	1 3/8	15.1	3310 1017 32
	5600	18'4 1/2"	34	1 11/32	17.6	3310 1016 94
	6400	21	33	1 5/16	19.8	3310 1016 97
	7200	23'7 1/2"	32	1 1/4	22.2	3310 1017 02
	8000	26'3"	31	1 7/32	24.6	3310 1017 07
	8800	28'9"	30	1 3/16	25.1	3310 1018 02
	9600	31'6"	29	1 5/32	30.4	3310 1017 12
	400	1'3 3/4"	35	1 3/8	1.7	3310 1016 83
	600	1'11 5/8"	35	1 3/8	2.4	3310 1016 84
	800	2'7 1/2"	34	1 11/32	3.0	3310 1016 85
	1200	3'11 1/4"	34	1 11/32	4.2	3310 1016 87
	1200	3'11 1/4"	33	1 5/16	4.3	3310 1016 98
	1600	5'3"	33	1 5/16	5.4	3310 1016 88
	1800	5'10 7/8"	33	1 5/16	6.1	3310 1016 96
	2000	6'6 3/4"	33	1 5/16	6.6	3310 1016 95
	2400	7'10 1/2"	32	1 1/4	7.9	3310 1017 00
	3200	10'6"	32	1 1/4	10.5	3310 1017 04
	3200	10'6"	31	1 7/32	10.3	3310 1017 05
	4000	13'1 1/2"	30	1 3/16	12.6	3310 1017 09
	4800	15'9"	29	1 5/32	15.1	3310 1017 10
	5600	18'4 1/2"	28	1 1/8	17.6	3310 1017 14

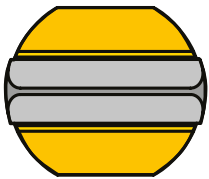

Integral H22 x 108 mm

25 mm (1") Chisel bit integral.

Rod hex. 22 mm (1") Shank hex. 22 mm (1") x 108 mm (4 1/4")

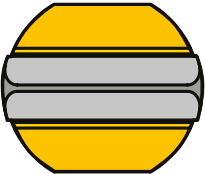
Description	Length (L)		Bit diameter		Weight approx.	Part number
	mm	ft/in	mm	in	kg	
 <p>Integral H25 x 108 mm</p>	600	1'11 5/8"	41	1 5/8	2.7	3310 1017 33
	800	2'7 1/2"	40	1 9/16	3.4	3310 1017 34
	1200	3'11 1/4"	40	1 9/16	4.9	3310 1017 35
	1600	5'3"	39	1 17/32	6.1	3310 1017 36
	1800	5'10 7/8"	39	1 17/32	6.9	3310 1017 37
	2400	7'10 1/2"	38	1 1/2	8.9	3310 1017 38
	400	1'3 3/4"	35	1 3/8	1.9	3310 1017 39
	400	1'3 3/4"	34	1 11/32	1.9	3310 1017 40
	600	1'11 5/8"	35	1 3/8	2.7	3310 1017 41
	800	2'7 1/2"	34	1 11/32	3.4	3310 1017 42
	800	2'7 1/2"	33	1 5/16	3.4	3310 1017 43
	1200	3'11 1/4"	34	1 11/32	4.8	3310 1017 44
	1600	5'3"	33	1 5/16	6.1	3310 1017 45
	2400	7'10 1/2"	32	1 1/4	9.0	3310 1017 46
	3200	10'6"	32	1 1/4	11.9	3310 1017 47
	3200	10'6"	31	1 7/32	11.7	3310 1017 48

19 mm (3/4") Chisel bit integral.

Rod hex. 19 mm (3/4") Shank hex. 19 mm (3/4") x 108 mm (4 1/4")

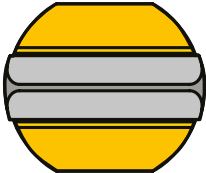
Description	Length (L)		Bit diameter		Weight approx.	Part number
	mm	ft/in	mm	in	kg	
 <p>Integral H19 x 108 mm</p>	400	1'3 3/4"	34	1 1/32	1.5	3310 1017 57
	800	2'7 1/2"	34	1 1/32	2.6	3310 1017 59
	800	2'7 1/2"	33	1 5/16	2.6	3310 1017 60
	1200	3'11 1/4"	34	1 1/32	3.6	3310 1017 61
	1600	5'3"	33	1 5/16	4.7	3310 1017 62
	2400	7'10 1/2"	32	1 1/4	6.8	3310 1017 63
	3200	10'6"	32	1 1/4	9.1	3310 1017 64
	3200	10'6"	31	1 7/32	8.9	3310 1017 65
	400	1'3 3/4"	29	1 5/32	1.1	3310 1017 66
	800	2'7 1/2"	28	1 1/8	1.9	3310 1017 67
	1600	5'3"	27	1 1/16	3.5	3310 1017 68
	2400	7'10 1/2"	27	1 1/16	6.8	3310 1017 69
	3200	10'6"	27	1 1/16	8.8	3310 1017 70
	800	2'7 1/2"	23	29/32	1.9	3310 1018 03
	600	1'11 5/8"	27	1 1/16	1.5	3310 1018 04

Shank End Rods R25 (1")



Description	Length (L)		Bit diameter		Weight approx.	Part number
	mm	ft/in	mm	in	kg	
Shank End Rod R25 (1"), H22 x 108 mm	265	10 3/8"	25	1	1.2	3310 1018 05
	610	2'	25	1	2.3	3310 1018 06
	760	2'5 7/8"	25	1	2.9	3310 1018 07
	1000	3'3 3/8"	25	1	3.4	3310 1018 08
	1200	3'11 1/4"	25	1	4.5	3310 1018 09
	1830	6'	25	1	6.2	3310 1017 85
	2435	8'	25	1	8.0	3310 1017 86
	3200	10'6"	25	1	10.4	3310 1017 87
	3600	11'9 3/4"	25	1	11.8	3310 1017 88
Shank End Rod R25 (1"), H25 x 108 mm	255	10"	25	1	1.5	3310 1017 89
	610	2'	25	1	3.1	3310 1017 90
	1200	3'11 1/4"	25	1	5.1	3310 1017 91
	1830	6'	25	1	7.7	3310 1017 92
	2435	8'	25	1	9.5	3310 1017 93

Plug Hole Rods
Shank 19 mm (3/4") x 108 mm (4 1/4")

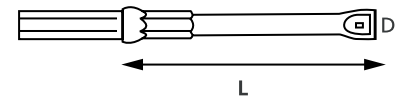

Description	Length (L)		Bit diameter		Weight approx.	Part number
	mm	ft/in	mm	in	kg	
Plug Hole Rod H19x108 MM, 200 MM, ø17 MM	200	7 7/8"	17	2 1/32	0.8	3310 1018 26
Plug Hole Rod H19x108 MM, 250 MM, ø17 MM	250	9 27/32"	17	2 1/32	0.9	3310 1018 27
Plug Hole Rod H19x108 MM, 300 MM, ø17 MM	300	11 13/16"	17	2 1/32	1	3310 1018 28
Plug Hole Rod H19x108 MM, 200 MM, ø20 MM	200	7 7/8"	20	25/32	0.8	3310 1018 29
Plug Hole Rod H19x108 MM, 250 MM, ø20 MM	250	9 27/32"	20	25/32	0.9	3310 1018 30
Plug Hole Rod H19x108 MM, 300 MM, ø20 MM	300	11 13/16"	20	25/32	1	3310 1018 31
Plug Hole Rod H19x108 MM, 200 MM, ø23 MM	200	7 7/8"	23	29/32	0.8	3310 1018 32
Plug Hole Rod H19x108 MM, 250 MM, ø23 MM	250	9 27/32"	23	29/32	0.9	3310 1018 33
Plug Hole Rod H19x108 MM, 300 MM, ø23 MM	300	11 13/16"	23	29/32	1	3310 1018 34

Plug Hole Rods
Shank 22 mm (7/8") x 108 mm (4 1/4")

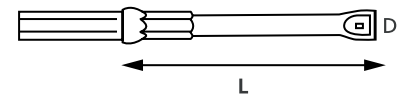

Description	Length (L)		Bit diameter		Weight approx.	Part number
	mm	ft/in	mm	in	kg	
Plug Hole Rod H22x108 MM, 200 MM, ø17 MM	200	7 7/8"	17	2 1/32	0.8	3310 1018 35
Plug Hole Rod H22x108 MM, 250 MM, ø17 MM	250	9 27/32"	17	2 1/32	0.9	3310 1018 36
Plug Hole Rod H22x108 MM, 300 MM, ø17 MM	300	11 13/16"	17	2 1/32	1	3310 1018 37
Plug Hole Rod H22x108 MM, 200 MM, ø20 MM	200	7 7/8"	20	25/32	0.8	3310 1018 38
Plug Hole Rod H22x108 MM, 250 MM, ø20 MM	250	9 27/32"	20	25/32	0.9	3310 1018 39
Plug Hole Rod H22x108 MM, 300 MM, ø20 MM	300	11 13/16"	20	25/32	1	3310 1018 40
Plug Hole Rod H22x108 MM, 200 MM, ø23 MM	200	7 7/8"	23	29/32	0.8	3310 1018 41
Plug Hole Rod H22x108 MM, 250 MM, ø23 MM	250	9 27/32"	23	29/32	0.9	3310 1018 42
Plug Hole Rod H22x108 MM, 300 MM, ø23 MM	300	11 13/16"	23	29/32	1	3310 1018 43

R25 Drill Bits

Description	Diameter	Gauge Carbide	Front Carbide	Side Carbide	Face Flushing	Gauge angle	Part number
	mm	mm	mm	mm	mm		
Drill Bit R25 (1"), 8 Buttons	33	6 x 7	2 x 7	1 x 5	2 x 5	35	3310 1017 94
Drill Bit R25 (1"), 8 Buttons	35	6 x 7	2 x 7	1 x 5	2 x 5		3310 1017 95
Drill Bit R25 (1"), 7 Buttons	37	6 x 7	2 x 7	1 x 5	2 x 5		3310 1017 96
Drill Bit R25 (1"), 9 Buttons	38	6 x 8	3 x 7	1 x 5	3 x 5		3310 1017 97
Drill Bit R25 (1"), 8 Buttons	41	6 x 8	2 x 8	1 x 5	2 x 5		3310 1017 98
Drill Bit R25 (1"), 9 Buttons	45	6 x 9	3 x 7	1 x 5	3 x 5		3310 1017 99
Drill Bit R25 (1"), 9 Buttons	48	6 x 10	3 x 9	1 x 6	3 x 5		3310 1018 00
Drill Bit R25 (1"), 9 Buttons	51	6 x 10	3 x 9	1 x 6	3 x 5		3310 1018 01

Drill rod

Tapered Rods

11° taper

Shank hex. 22 mm (7/8") x 108 mm (4 1/4"). Rod hex. 22 mm (7/8")

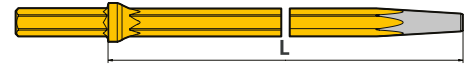

Description	Length (L)		Weight approx.	Part number
	mm	ft/in	kg	
Tapered Rods 11°, H22 x 108 mm	610	2	2.4	3310 1016 62
	1220	4	4.2	3310 1016 63
	1525	5	5.3	3310 1016 64
	1830	6	5.9	3310 1016 65
	2000	6'6 3/4"	6.6	3310 1016 66
	2435	8	7.7	3310 1016 67
	2600	8'6 3/8"	8.2	3310 1016 68
	3200	10'6"	10.3	3310 1016 69

Penetration rate 25-50% higher compared to Integral steel

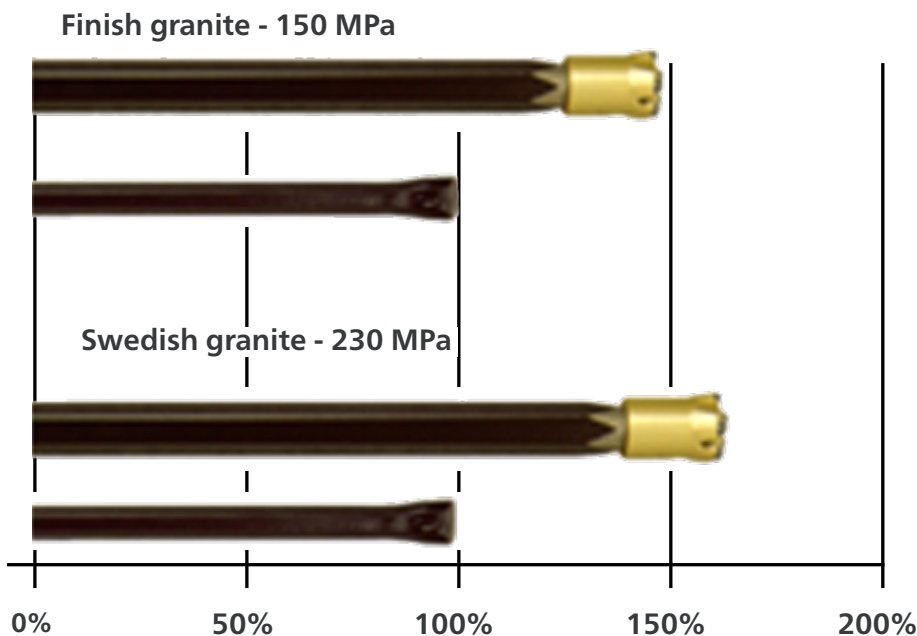

Tapered equipment gives you these features

- Better penetration rate
- Longer service life
- Longer intervals between regrinding
- Easier to adapt to different rock conditions
- Less risk of getting stuck
- Easier collaring
- Easier to drill straight holes
- Less vibrations
- Tapered bits are easier to transport

Tapered Rods

12° taper

Shank hex. 22 mm (7/8") x 108 mm (4 1/4"). Rod hex. 22 mm (7/8").

Description	Length (L)		Weight approx.	Part number
	mm	ft/in	kg	
Tapered Rods 12°, H22 x 108 mm	610	2	2.4	3310 1018 12
	1220	4	4.2	3310 1018 13
	1525	5	5.3	3310 1018 14
	1830	6	5.9	3310 1018 15
	2000	6'6 3/4"	6.6	3310 1018 16
	2435	8	7.7	3310 1018 17
	2600	8'6 3/8"	8.2	3310 1018 18
	3200	10'6"	10.3	3310 1018 19

Tapered Bits

Description	Diameter		No. of buttons	Buttons x button diameter (mm)		Gauge buttons angle°	Front buttons angle°	Flushing hole		Weight approx.	Part number
	mm	in		Gauge	Centre			Side	Centre	kg	
Tapered Bits 7° H22x108mm	30	1 3/16	6	4 x 7	2 x 7	35°	–	1	2	0.3	3310 1023 30
	32	1 1/4	8	6 x 7	2 x 7	35°	15	1	2	0.3	3310 1023 31
	33	1 5/16	8	6 x 7	2 x 7	35°	15	1	2	0.3	3310 1023 32
	34	1 11/32	8	6 x 7	2 x 7	35°	15	1	2	0.3	3310 1023 33
	36	1 13/32	7	5 x 8	2 x 7	35°	–	1	1	0.3	3310 1023 34
	38	1 1/2	7	5 x 9	2 x 7	35°	–	1	1	0.3	3310 1023 35
	41	1 5/8	7	5 x 9	2 x 7	35°	–	1	1	0.3	3310 1023 36
Tapered Bits 11° H22 x 108 mm	32	1 1/4	8	6 x 7	2 x 7	39°	15°	1	1	0.3	3310 1016 70
	33	1 5/16	8	4 x 7	2 x 7	40°	–	1	1	0.2	3310 1016 71
	34	1 11/32	8	6 x 7	3 x 7	40°	20°	2	–	0.3	3310 1016 72
	36	1 13/32	7	5 x 8	2 x 7	35°	–	1	1	0.3	3310 1016 73
	38	1 1/2	7	5 x 9	2 x 7	35°	–	1	1	0.3	3310 1016 74
	41	1 5/8	7	5 x 9	2 x 7	35°	–	2	1	0.3	3310 1016 75
Tapered Bits 12° H22 x 108 mm	32	1 1/4	8	6 x 7	2 x 7	39°	15°	1	1	0.3	3310 1018 20
	33	1 5/16	8	4 x 7	2 x 7	40°	–	1	1	0.2	3310 1018 21
	34	1 11/32	8	6 x 7	3 x 7	40°	20°	2	–	0.3	3310 1018 22
	36	1 13/32	7	5 x 8	2 x 7	35°	–	1	1	0.3	3310 1018 23
	38	1 1/2	7	5 x 9	2 x 7	35°	–	1	1	0.3	3310 1018 24
	41	1 5/8	7	5 x 9	2 x 7	35°	–	2	1	0.3	3310 1018 25

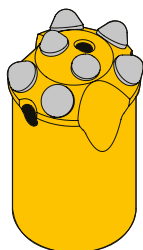

All round bit for medium-hard to hard rock.
Front and side flushing. Inclined front buttons.

Service Offer For Pneumatic Tools

Airline hoses for pneumatic tools



X- LITE: 100 % safety and operating comfort

As compressed air application for demanding jobs, X- LITE pneumatic hoses offer a perfectly safe transfer of compressed air into the machines – at almost any working condition for professional drills and breakers.

X- LITE stands for maximum operator comfort, as lightweight flat hoses are much more easy to handle than conventional heavy and bulky ones. With maximum safety included: Manufactured with a woven reinforcement, they remain extremely resistant to bursting or tearing during a long lifetime.

In addition, the X- LITE range offers customised versions – in order to identify company equipment clearly on the site.

The benefits of X- LITE, at a glance:

Fast on long stretches

X- LITE is extremely flexible and can be easily unrolled.

Ideal size and weight

X- LITE is only one - fifth the thickness of a conventional rubber hose and requires 50 % less storage space. Furthermore, it weighs three times less.

5-fold safety

With an operating pressure of 20 bar, the bursting pressure is above 100 bar.

No whipping

Should the X- LITE tear, the crack will progress in a longitudinal and never in a transverse direction. Advantage: the hose remains in one piece and there are no whipping ends.

X-Lite Flat Hoses

Hose rolls



	Description	Inner diameter		Thickness		Max. working pressure		Length of roll		Weight	Content	Part number
		mm	in	mm	in	bar	psi	m	ft	kg ¹⁾		
Lightweight hose		20	¾	2.0	⅝ ₆₄	20	290	60	195	11		9030 2114 00
		20	¾	2.5	⅝ ₆₄	20	290	100	325	18		9030 2114 01
		20	¾	2.5	⅝ ₆₄	20	290	200	650	36		9030 2114 02
		25	1	2.5	⅝ ₆₄	20	290	60	195	15		9030 2106 00
		25	1	2.5	⅝ ₆₄	20	290	100	325	25		9030 2106 01
		25	1	2.5	⅝ ₆₄	20	290	200	650	50		9030 2106 02
		40	1 ½	2.5	⅝ ₆₄	14	200	60	195	27		9030 2107 00
		50	2	2.8	⅞ ₆₄	14	200	60	195	33		9030 2108 00
Hose X-Lite		50	2	-	-	14	200	200	650	110		9030 2108 02
Lightweight hose		76	3	3.0	⅛	10	145	40	130	38		9030 2109 00

Extra value!

1,000 + 200 m packages

Lightweight hose (20 x 60 m)	20	¾	2.0	⅝ ₆₄	20	290	60	195	220	20 x 9030 2114 00	9030 2114 80
Package of 10 rolls (10 x 60 m)	20	¾	2.0	⅝ ₆₄	20	290	60	195	110	10 x 9030 2114 00	9030 2114 90
Lightweight hose (12 x 100 m)	20	¾	2.5	⅝ ₆₄	20	290	100	325	220	12 x 9030 2114 01	9030 2114 81
Lightweight hose (6 x 200 m)	20	¾	2.5	⅝ ₆₄	20	290	200	650	220	6 x 9030 2114 02	9030 2114 82
Lightweight hose (20 x 60 m)	25	1	2.5	⅝ ₆₄	20	290	60	195	280	20 x 9030 2106 00	9030 2106 80
Lightweight hose (12 x 100 m)	25	1	2.5	⅝ ₆₄	20	290	100	325	280	10 x 9030 2106 01	9030 2106 81
Lightweight hose (6 x 200 m)	25	1	2.5	⅝ ₆₄	20	290	200	650	280	6 x 9030 2106 02	9030 2106 82

X-LITE flat hoses

Pre-mounted hoses



	Description	Inner diameter		Thickness		Max. working pressure		Length of roll		Weight	Content	Part number
		mm	in	mm	in	bar	psi	m	ft	kg ¹⁾		
Universal		20	¾	2.0	⅝ ₆₄	20	290	20	65	4.5		9030 2115 00
		20	¾	2.0	⅝ ₆₄	20	290	15	49	3.5		9030 2115 15
	RH 571, 572E, 658	20	¾	2.0	⅝ ₆₄	20	290	3	10	1		9030 2163 00
		25	1	2.0	⅝ ₆₄	20	290	20	65	6		9030 2111 00
Extra value!												
500 + 100 m packages	Universal (30 x 20 m)	20	¾	2.0	⅝ ₆₄	20	290	20	65	135	30 x 9030 2115 00	9030 2115 80
	Universal (30 x 20 m)	25	1	2.0	⅝ ₆₄	20	290	20	65	180	30 x 9030 2111 00	9030 2111 80

¹⁾ 1 kg = 2.2 lb

UNBEATABLE – A CLASS

High-pressure applications: the pre-assembled H-Lite pneumatic hose from Atlas Copco ensures that compressed air is safely transported from the compressor to the drill rig, e.g. during water well boring or other drilling applications.

The high-pressure hose is extremely lightweight, easy to handle and very safe: A twin jacketed made of high-strength reinforced tissue – coated on the inside and outside with oil-resistant polyurethane – makes the H-Lite extremely resistant against bursting and tearing.

The high-pressure hose has been developed especially for secure and flexible transportation of compressed air between compressor and drill rig.

High-pressure hoses are flexible, lightweight and safe. The 5-fold safety ensures that with an operating pressure of 30 bar, the bursting pressure is above 150 bar.

Features

- Lightweight, yet rugged and hardwearing hose
- The low weight combined with a high pressure rating makes the hose popular and easy to use
- The hose does not stretch when pulled and has a very high pressure rating versus wall thickness
- Excellent abrasion resistance

Design

- Made from a blend of nitrile rubber and PVC with an added UV barrier to prevent damage from UV radiation
- The rubber blend is extruded through a circular woven jacket made from high tenacity filament polyester yarn



H-Lite hoses

High-pressure hoses, premounted with couplings and without couplings

Max. working pressure below is calculated with safety factor 5. Burst pressure = 5x max. working pressure

	Description	Inner diameter		Max. working pressure		Length of roll		Weight	Working temperature		Part number
		mm	in	bar	psi	m	ft	kg ¹⁾	°C	°F	
New	H-Lite hose- W coupling	50	2	40	580	20	65	17	-30 to +100	-20 to +210	9030 2078 35
		50	2	40	580	40	130	32	-30 to +100	-20 to +210	9030 2079 35
		20	¾	20	290	30	98	7	-30 to +100	-20 to +210	3310 1016 53
		20	¾	20	290	60	196	13	-30 to +100	-20 to +210	3310 1016 54
		25	1	20	290	30	98	7	-30 to +100	-20 to +210	3310 1016 55
		25	1	20	290	60	196	13	-30 to +100	-20 to +210	3310 1016 56
	H-Lite hose- W/O Coupling	20	¾	20	290	30	98	7	-30 to +100	-20 to +210	3310 1016 57
		20	¾	20	290	60	196	13	-30 to +100	-20 to +210	3310 1016 58
		25	1	20	290	30	98	7	-30 to +100	-20 to +210	3310 1016 59
		25	1	20	290	60	196	13	-30 to +100	-20 to +210	3310 1016 60
	H-Lite hose	50	2	40	580	30	98	24	-30 to +100	-20 to +210	3310 1016 61

¹⁾ 1 kg = 2.2 lb

Hose

Double jacket design with both inner and outer layer made of oil-resistant polyurethane. Reinforced, high-strength textile yarn.

Hose nipple

Hose nipples with a two-inch connection thread according to SMS 681 / DIN 405 require an appropriate coupling nipple for the BSP thread which has the part number 9000 0032 00 G2A. The hoses can be connected using the coupling nipples 90000032 00 and 9000 0037 00.

Articles for secure operation

The high-pressure hose must be secured at both ends, both at the compressor and the drilling trolley or equivalent. The hose is secured with the aid of the following articles, which are ordered separately:

- Hose stocking 3163 1852 00
- Chain 3163 1853 00
- Shackle 3163 1854 00

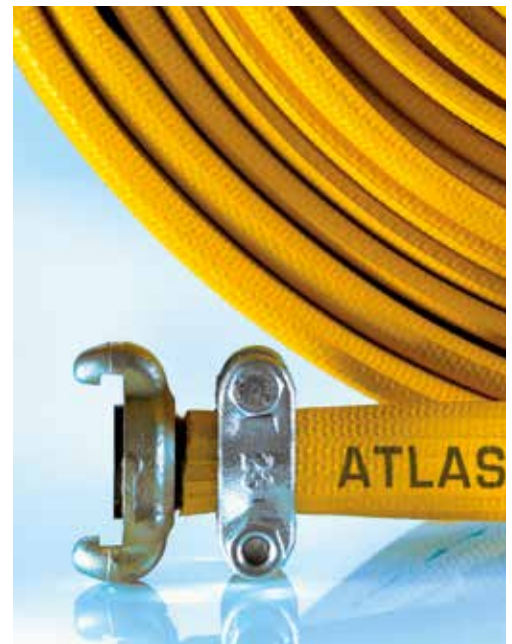





Round Rubber Hoses

Atlas Copco rubber hose is a heavy-duty product that will withstand rough handling. It is suitable for the most demanding tasks in construction, roadwork, mining, shipbuilding etc. Maximum working pressure is 16 Bar with 5 fold-safety. Inner lining in black EPDM rubber, conductive to dissipate static electricity. Reinforcement with high tensile strength made of synthetic textile yarns.

Hose rolls

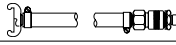
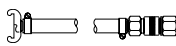
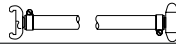
	Description	Inner diameter		Outer diameter		Max. working pressure		Length roll		Weight	Part number
		mm	in	mm	in	bar	psi	m	ft	kg ¹⁾	
	Rubber hose	10	3/8	17	1 1/16	16	232	30	98	6.9	9030 2037 00
		12.5	1/2	22	5/8	16	232	30	98	12.3	9030 2038 00
		16	5/8	25	1	16	232	30	98	13.9	9030 2039 00
		20	3/4	30	1 3/16	16	232	30	98	19.3	9030 2040 00
		20	3/4	30	1 3/16	16	232	20	65	12.9	9030 2040 03
		25	1	36	1 5/16	16	232	30	98	24.0	9030 2041 00
		25	1	36	1 5/16	16	232	20	65	16.0	9030 2041 03

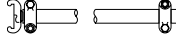
pre-mounted hoses fitted with couplings and hose clamps

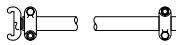
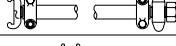
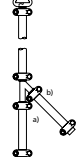
	Description	Inner diameter		Outer diameter		Max. working pressure		Length of roll		Weight	Part number
		mm	in	mm	in	bar	psi	m	ft	kg ¹⁾	
	DKR 36	10	3/8	17	1 1/16	16	232	3	10	0.9	9030 2042 00
	TEX 3, 05	12.5	1/2	22	5/8	16	232	3	10	1.2	9030 2043 00
		12.5	1/2	22	5/8	16	232	3	10	1.5	9030 2090 00
	TEX 09, 10, 11, 12	12.5	1/2	22	5/8	16	232	3	10	1.2	9030 2044 00
	Universale	12.5	1/2	22	5/8	16	232	15	49	5.9	9030 2045 00
		20	3/4	30	1 3/16	16	232	15	49	7.6	9030 2049 00
		25	1	36	1 5/16	16	232	15	49	12	9030 2050 00
	BBD 12 D/DS	12.5	1/2	22	5/8	16	232	3	10	1.5	9030 2066 00
		20	3/4	22	5/8	16	232	3	10	2	9030 2100 00
	With US claw coupling	12.5	1/2	22	5/8	16	232	3	10	1.5	9030 2064 00
	BBD 15ET	15	5/8	25	1	16	232	3	10	1.7	9030 2046 00
	RH 571, 572E, 656W, 658, . BBD 12T, 12TS, 15E	20	3/4	30	1 3/16	16	232	3	10	2.1	9030 2047 00
	With US claw coupling	20	3/4	30	1 3/16	16	232	3	10	2.1	9030 2065 00
	BBC 16W, BBC 34, . BBD 46, 94 DSI	25	1	36	1 5/16	16	232	3	10	2.5	9030 2051 00
	Water /air flushing hose . for BBC, BBD, RH	12.5	1/2	22	5/8	16	232	0.6	2 1/2	0.4	9030 2069 00
	TEX 14PS - TEX 40PE	20	3/4	30	1 3/16	16	232	3	10	2.0	9030 2048 00
	RH 656W for pusher leg	20	3/4	30	1 3/16	13	188	3.6	12	3.5	9030 2067 00
	BBD 94W for pusher leg	25	1	36	1 5/16	13	188	3.6	12	4.4	9030 2068 00

¹⁾ 1 kg = 2.2 lb

Hose selection can be made based on applications



Max. working pressure	25 - 40 bar	20 bar	16 bar
Bursting pressure	> 150 bar	> 100 bar	< 80 bar
Inner Diameter	20 - 50 mm	20- 75 mm	10 - 25 mm
Physical endurance	High	Medium	Medium
UV Protection	Yes	No	No
Life time	High	Moderate	Moderate

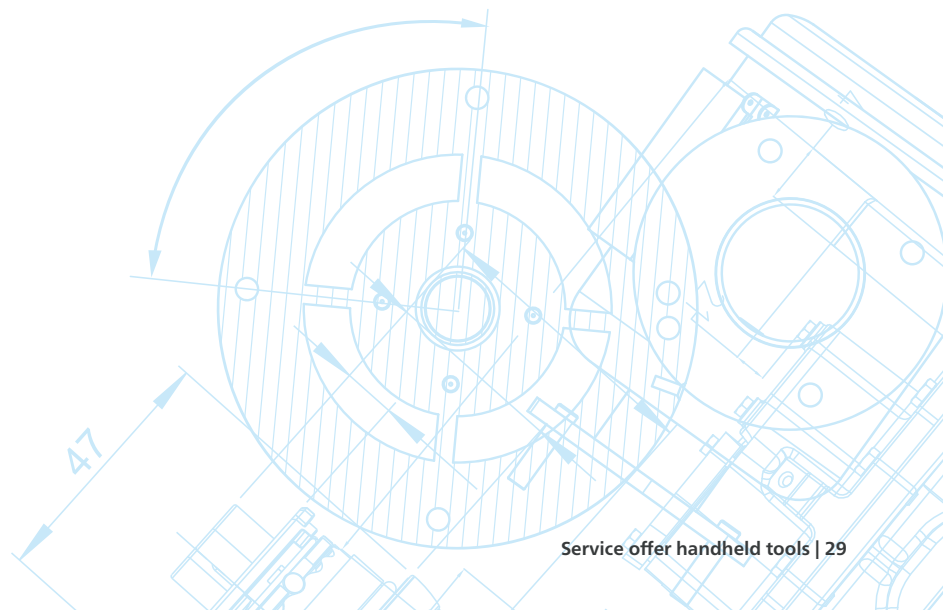

Professional Air Line Accessories

Atlas Copco forged and hardened Claw Couplings for maximum service life and flow.



Air flow

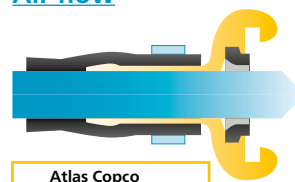

Atlas Copco forged coupling

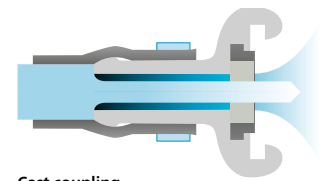

Cast coupling

A top-quality claw coupling has thin walls, allowing maximum air flow.

Pressure loss

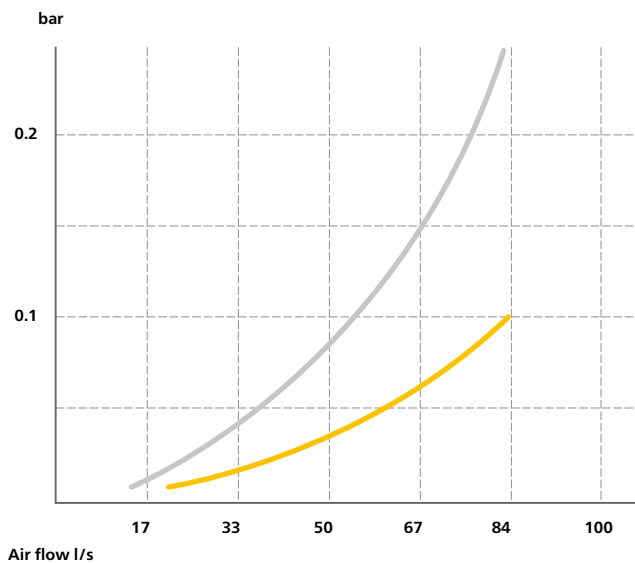

Cast coupling

Atlas Copco forged coupling



As few as six inferior, flow-choking couplings in the system can result in a power loss of 20 % or more.





Productivity

A 20% power loss means that at least 20% less work is done.





Claw couplings for maximum airflow (forged)

	Connection	Hose inner diameter		Bore		Weight kg ¹⁾	Part number
		mm	in	mm	in		
	Hose nipple	6.3	¼	5.0	¾ ₁₆	0.11	9000 0308 00
		10.0	⅜	8.0	5 ₁₆	0.13	9000 0309 00
		12.5	½	10.5	13 ₃₂	0.14	9000 0310 00
		16.0	5 ₈	13.5	17 ₃₂	0.14	9000 0311 00
		20.0	¾	17.2	11 ₁₆	0.15	9000 0312 00
		25.0	1	22.0	7 ₈	0.17	9000 0313 00
	Hose nipple with lock nut	10.0	⅜	8.0	5 ₁₆	0.29	9000 0260 00
		12.5	½	10.5	13 ₃₂	0.29	9000 0261 00
		16.0	5 ₈	13.5	17 ₃₂	0.29	9000 0262 00
		20.0	¾	17.2	11 ₁₆	0.32	9000 0263 00
		25.0	1	22.0	7 ₈	0.32	9000 0264 00

	Connection	Connection thread	Bore		Weight kg ¹⁾	Part number
			mm	in		
	External thread	G ⅜ A	11.3	7 ₁₆	0.11	9000 0300 00
		G ½ A	14.8	37 ₆₄	0.12	9000 0301 00
		G ¾ A	19.0	¾	0.13	9000 0302 00
		G1A	25.5	1	0.13	9000 0303 00
	Internal thread Internal thread	G ⅜	15.0	19 ₃₂	0.12	9000 0304 00
		G ½	18.6	¾	0.13	9000 0305 00
		G ¾	24.2	1	0.14	9000 0306 00
	Internal thread, with strainer	G ¾	24.2	1	0.14	9000 0306 01
	Internal thread	G1	30.3	1 3 ₁₆	0.15	9000 0307 00
	Cover	-	-	-	0.18	9000 0314 00
	Forged claw coupling	G½A (M-AUS)	14.8	37 ₆₄	0.12	9001000301
		G1A (M-AUS)	25.5	1	0.13	9001000303
		G½ (F-AUS)	18.6	¾	0.13	9001000305
		G1 (F-AUS)	30.3	1 3 ₁₆	0.15	9001000307
	Forged claw coupling 10.0 mm	(HN-AUS)	-	-	-	9001000310
	Forged claw coupling 25.0 mm	(HN-AUS)	-	-	-	9001000313

¹⁾ 1 kg = 2.2 lb



Packings and lock springs for claw couplings (forged)

	Description	Fit to coupling	Comment	Part number
		Part number 9000 ...		
	Packing	0300 00 to 0314 00	Can be replaced by special packing 9000 0000 01 ¹⁾	9000 0000 00
		0260 00 to 0262 00	-	9000 0015 00
		0263 00 and 0264 00	Can be replaced by special packing 900 00319 00 ¹⁾	9000 0268 00
	Lock spring	Fits to all 9000 0300 00 to 9000 0314 00 couplings	-	3176 8640 00
-	Strainer	Fits to 9000 0306 01	-	9000 0000 10

¹⁾ Special packings can be used in max. +2 00°C (390°F) steam and – 40°C to + 250°C (– 40°F to + 482°F) air. Excellent for neutral and alkaline liquids (ph above 5)



Claw couplings, US type (casted)

	Connection	Hose inner diameter		Bore		Weight	Part number
		mm	in	mm	in	kg ¹⁾	
	Hose nipple	10.0	3/8	6	5/64	0.16	9001 0005 11
		12.5	1/2	9	23/64	0.18	9001 0005 10
		20.0	3/4	14	9/16	0.24	9001 0005 12
		25.0	1	20	3/4	0.29	9001 0005 13

	Connection	Connection thread	Bore		Weight	Part number
			mm	in	kg ¹⁾	
	External thread	3/8" NPT	9	23/64	0.18	9001 0005 00
		1/2" NPT	12	15/32	0.19	9001 0005 01
		3/4" NPT	17	43/64	0.22	9001 0005 02
		1" NPT	20	3/4	0.26	9001 0005 03
	Internal thread	3/8" NPT	15	19/32	0.18	9001 0005 08
		1/2" NPT	18	23/32	0.18	9001 0005 05
		3/4" NPT	20	3/4	0.20	9001 0005 06
		1" NPT	20	3/4	0.22	9001 0005 07
	Cover	-	-	-	0.22	9001 0005 22

¹⁾ 1 kg = 2.2 lb

Packings and lock springs for US type claw couplings

	Description	Fit to coupling	Part number
		Part number 9001 0005 ..	
	Packing	00 to 22	9001 0005 15
	Lock pin	00 to 22	9001 0005 23

Hose Clamps for US type forged Claw Couplings 9001 0005 11 to 9001 0005 22

NEW	Description	Hose dimension, external diameter		Round rubber, hose dimension, internal diameter		Flat hose dimension, internal diameter		Part number
		mm	in	mm	in	mm	in	
	Two piece hose clamp	22 – 29	7/8 – 1 1/8	12.5	1/2	20	3/4	9000 0050 00
		29 – 32	1 1/8 – 1 3/8	20	3/4	25	1	9000 0051 00

Dust Collector



	Description	Comment	Part number
	Tool holder CPL	for Breaker	3310 1011 08
	Suction hood	for Rock drill	3310 1007 98
	Trolley	-	8311 03251 4
	Plastic bag kit (50 Pcs)	-	3310 1013 53
	Bellow kit (10 Pcs)	-	3310 1013 52
	Filter Kit (4 Pcs)	-	3310 1013 85
	DCP 10 Two Tool Kit	-	8311 0325 18

Hose Clamps for Atlas Copco forged claw couplings 9000 0300 00 to 9000 0314 00

	Description	Hose dimension, external diameter		Round rubber, hose dimension, internal diameter		Flat hose dimension, internal diameter		Part number
		mm	in	mm	in	mm	in	
	Two-piece hose clamp	22 – 29	$\frac{7}{8} - 1$	12.5	$\frac{1}{2}$	20	$\frac{3}{4}$	9000 0194 00
		25 – 28	$1 - 1 \frac{1}{8}$	16	$\frac{5}{8}$	-	-	9000 0195 00
		29 – 32	$1 \frac{1}{8} - 1 \frac{1}{4}$	20	$\frac{3}{4}$	25	1	9000 0196 00
		34 – 38	$1 \frac{3}{8} - 1 \frac{1}{2}$	25	1	-	-	9000 0197 00
		43 – 47	$1 \frac{3}{4} - 1 \frac{7}{8}$	31.5	$1 \frac{1}{4}$	40	$1 \frac{1}{2}$	9000 0381 00
		54 – 58	$2 \frac{1}{8} - 2 \frac{1}{4}$	40	$1 \frac{1}{2}$	50	2	9000 0198 01
		66 – 70	$2 \frac{5}{8} - 2 \frac{3}{4}$	50	2	-	-	9000 0199 00
		78 – 82	$3 \frac{1}{8} - 3 \frac{1}{4}$	63	$2 \frac{1}{2}$	76	2	9000 0189 00

Double hose clamps are required for hose dimensions over 25 mm (1 in) internal diameter.



Hose nipples

	Description	Bore		Hose dimension, internal diameter		Part number
		mm	in	mm	in	
	Hose jointing nipple	9	$\frac{23}{64}$	10	$\frac{3}{8}$	9000 0215 00
		12	$\frac{15}{32}$	12.5	$\frac{1}{2}$	9000 0216 00
		14	$\frac{9}{16}$	16	$\frac{5}{8}$	9000 0217 00
		17	$\frac{43}{64}$	20	$\frac{3}{4}$	9000 0218 00
		22	$\frac{29}{32}$	25	1	9000 0219 01
		35	$1 \frac{3}{8}$	40	$1 \frac{1}{2}$	9000 0220 00
		44.5	$1 \frac{3}{4}$	50	2	9000 0221 00
	Hose nipple for cup nut	10.5	$\frac{13}{32}$	12.5	$\frac{1}{2}$	9000 0322 00
		8	$\frac{5}{16}$	12.5	$\frac{1}{2}$	9000 0323 01
		13.5	$\frac{17}{32}$	16	$\frac{5}{8}$	9000 0324 00
		17.2	$\frac{11}{16}$	20	$\frac{3}{4}$	9000 0325 00
		22	$\frac{7}{8}$	25	1	9000 0326 00
	Hose nipple with particulary coarse thread	10.5	$\frac{13}{32}$	12.5	$\frac{1}{2}$	9000 0370 00
		17.2	$\frac{11}{16}$	20	$\frac{3}{4}$	9000 0371 00
		20	$\frac{3}{4}$	25	1	9000 0372 00
		35	$1 \frac{3}{8}$	40	$1 \frac{1}{2}$	9000 0373 00
		45	$1 \frac{3}{4}$	50	2	9000 0374 00
		64	$2 \frac{1}{2}$	76	3	9001 0025 80

Connecting nipples

	Description	Thread		Part number
		A	B	
Hose couplings with screw connection 	External	G ¾ A	G ¾ A	9000 0343 00
	External	G 7/8 A	G 1 A	9000 0345 00
Hose couplings with particularly coarse thread 	External	Rd 38 - 8	G ½ A	9000 0028 00
	External	Rd 38 - 8	G ¾ A	9000 0029 00
	External	Rd 38 - 8	G 1 A	9000 0030 00
	External	Rd 65 - 6	G 1 ½ A	9000 0031 00
	External	Rd 65 - 6	G 2 A	9000 0032 00
	Internal	Rd 38 - 8	G ¾	9000 0034 00
	Internal	Rd 38 - 8	G 1	9000 0035 00
	Internal	Rd 65 - 6	G 1 ½	9000 0036 00
	Internal	Rd 65 - 6	G 2	9000 0037 00

Cup nuts



	Description	Thread	Part number
		mm	
Hose couplings with screw connection 	Wing nut	G ¾	9000 0337 00
	Wing nut	G 7/8	9000 0338 00
	Wing nut	G 1 ½	9000 0339 00
	Internal	G 5/8	9000 0331 00
	Internal	G ¾	9000 0332 00
	Internal	G 7/8	9000 0333 00

	Description	Thread	Part number
		mm	
Hose couplings with particularly coarse thread 	Wing nut	Rd 38 - 8	9000 0154 00
	Wing nut	Rd 65 - 6	9000 0159 00

Overview: hose couplings for rubber hoses

Hose diameter inner		Hose jointing nipple	Hose clamp	Hose clamp	Hose nipple	Cup nut wing	Cup nut hexagon	Connecting nipples External thread
mm	in							
								
10	3/8	9000 0215 00	0347 6105 00	-	-	-	G 5/8 9000 0331 00	-
12.5	1/2	9000 0216 00	-	9000 0194 00	9000 0322 00	-	G 5/8 9000 0331 00	-
12.5	1/2	-	-	-	9000 0323 01	9000 0337 00	G 3/4 9000 0332 00	-
16	5/8	9000 0217 00	-	9000 0195 00	9000 0324 00	9000 0337 00	G 3/4 9000 0332 00	G 3/4 A - G 3/4 A 9000 0343 00
20	3/4	9000 0218 00	-	9000 0196 00	9000 0325 00	9000 0338 00	G 7/8 9000 0333 00	G 7/8 A - G 1 A 9000 0345 00
25	1	9000 0219 01	-	9000 0197 00	9000 0326 00	9000 0339 00	-	-

Overview: hose couplings with particulary coarse thread for rubber hoses









Hose diameter inner		Hose clamp	Hose nipple	Packing ¹⁾	Cup nut wing	Connecting nipples External thread	Connecting nipples Internal thread
mm	in						
							
12.5	1/2	9000 0194 00	9000 0370 00	9000 0025 00 ²⁾	9000 0154 00	G 1/2 A 9000 0028 00	-
20	3/4	9000 0196 00	9000 0371 00	9000 0025 00 ²⁾	9000 0154 00	G 3/4 A 9000 0029 00	G 3/4 9000 0034 00
25	1	9000 0197 00	9000 0372 00	9000 0025 00 ²⁾	9000 0154 00	G 1 A 9000 0030 00	-

¹⁾ Packing is included with the hose nipple. ²⁾ Alternatively 9000 0399 00, packing for steam max + 200°C (+ 392°F).
Air - 40°C to + 250°C (- 40°F to + 482°F).

Overview: hose couplings for flat hoses

Hose diameter inner		Hose jointing nipple	Hose clamp	Claw coupling	Packing
mm	in				
					
20	3/4	9000 0218 00 ¹⁾	9000 0194 00	9000 0312 00	9000 0000 00 ³⁾
25	1	9000 0219 01 ¹⁾	9000 0196 00	9000 0313 00	9000 0000 00 ³⁾

Overview: hose couplings with particulary coarse thread for rubber hoses

Hose diameter inner		Hose jointing nipple	Hose clamp	Hose nipple	Packing	Cup nut wing	Connecting nipples External thread	Connecting nipples Internal thread
mm	in							
								
40	1 1/2	9000 0220 00 ²⁾	9000 0381 00	9000 0373 00	9000 0026 00 ³⁾	9000 0159 00	G 1/2 A 9000 0031 00	G 1/2 9000 0036 00
50	2	9000 0221 00 ²⁾	9000 0198 01	9000 0374 00	9000 0026 00 ³⁾	9000 0159 00	G 2 A 9000 0032 00	G 2 9000 0037 00
76	3	-	9000 0189 00	9001 0025 80	-	-	-	-

¹⁾ 2 hose clamps per nipple needed ²⁾ 4 hose clamps per nipple needed ³⁾ All claw couplings and hose nipples supplied complete with packings



Branch pipes

	Connection		Max. working pressure		Bore		Part number
	mm	in	bar	psi	mm	in	
for hose connection							
	20 x 20 x 12.5	3/4 x 3/4 x 1/2	13	188	17 x 17 x 12	1 1/16 x 1 1/16 x 1/2	9000 0440 00
	25 x 25 x 12.5	1 x 1 x 1/2	13	188	23 x 23 x 12	29/32 x 29/32 x 1/2	9000 0441 00

VAM Water Separators

- For trouble-free ownership
- For long lifetime
- For protected investment



Water condensate is always present in compressed air systems. Up to a bucket of water per shift can be produced by condensation. This water must be removed to minimize corrosion and freezing problems.

Vam water separators operate on the centrifugal principle with automatic emptying of the condensate.

So you can focus on what you can do best: your job.



Water separators, fitted with claw couplings

	Description	Hose connection		Air flow		Weight kg ¹⁾	Part number claw couplings	
		mm	in	l/s	cfm		European type	US type
	VAM 01	20	¾	50	106	0.8	8092 0110 58	8092 0110 59
	VAM 5A	25	1	120	254	10	8092 0110 82	8092 0110 83

¹⁾ 1 kg = 2.2 lb Max. working pressure 8 bar (115 psi)

When air is compressed less space is available for dissolved water. In the end, it condenses and becomes visible droplets.

If the system only has one air user, a smaller water separator is sufficient. A fixed "turbine wheel" starts a lengthwise swirl that forces water against walls, where it is collected and fed out of the system.

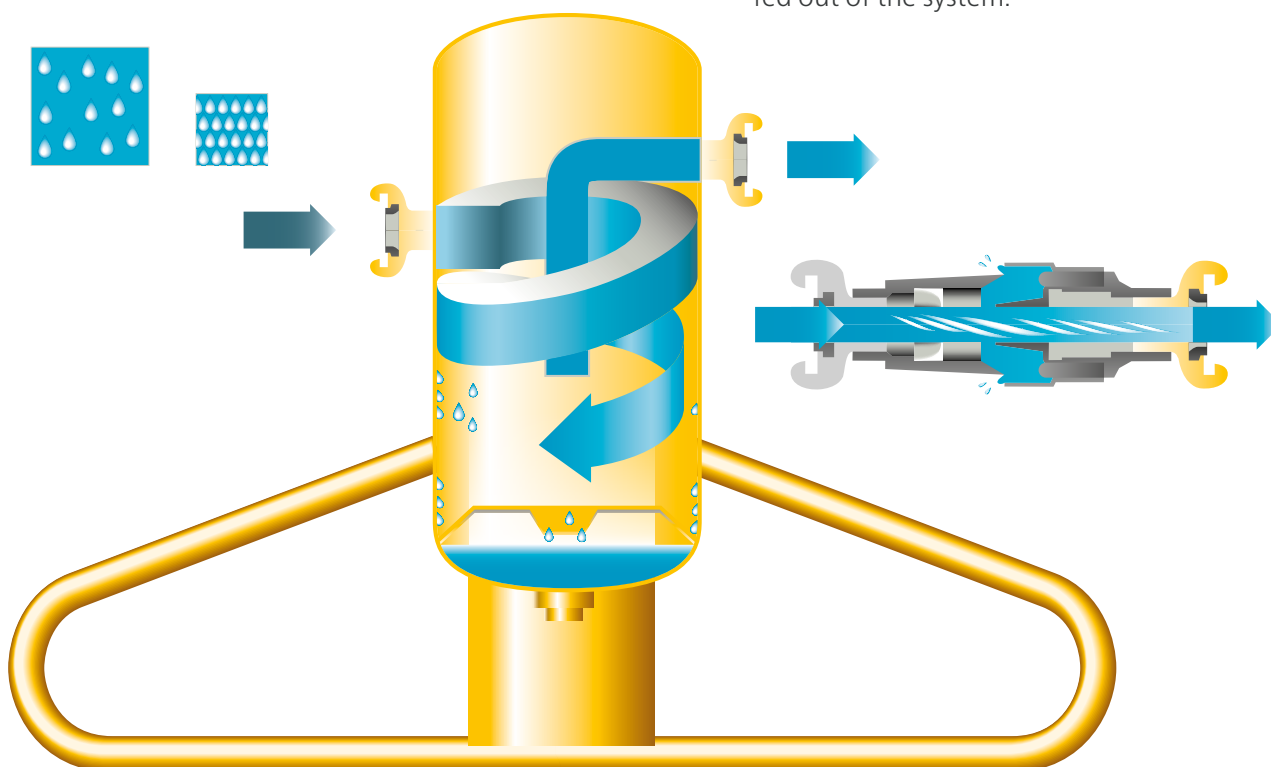

BLG/CLG lubricators

- For secure oil supply
- For reliable functionality in all working positions
- For trouble-free ownership
- For longer lifetime
- for protected investment

Any pneumatic machine without built-in lubrication needs a separate lubricator to ensure that all moving parts are continuously covered with a film of oil.

Atlas Copco lubricators are designed to work in any position, horizontal, vertical or upside-down. This secures a continuous oil supply to protect the machine.

BLG and CLG lubricators use the ejector principle and ensure effective lubrication of all compressed-air machines.

Lubricators, fitted with claw couplings

	Description	Hose connection		Air flow		Oil volume		Weight kg ¹⁾	Part number claw couplings	
		mm	in	l/s	cfm	l	gal		European type	US type
	CLG 30, for both mineral and synthetic oil	25	1	15 – 140	32 – 300	1.3	0.3	3	8202 5102 39	8202 5102 40
	BLG 30, for mineral oil	25	1	15 – 140	32 – 300	1.3	0.3	3	8202 5102 05	8202 5102 14

¹⁾ 1 kg = 2.2 lb Max. working pressure 20 bar (290 psi)

A check valve stops oil from reaching the air path when the system is unpressurized

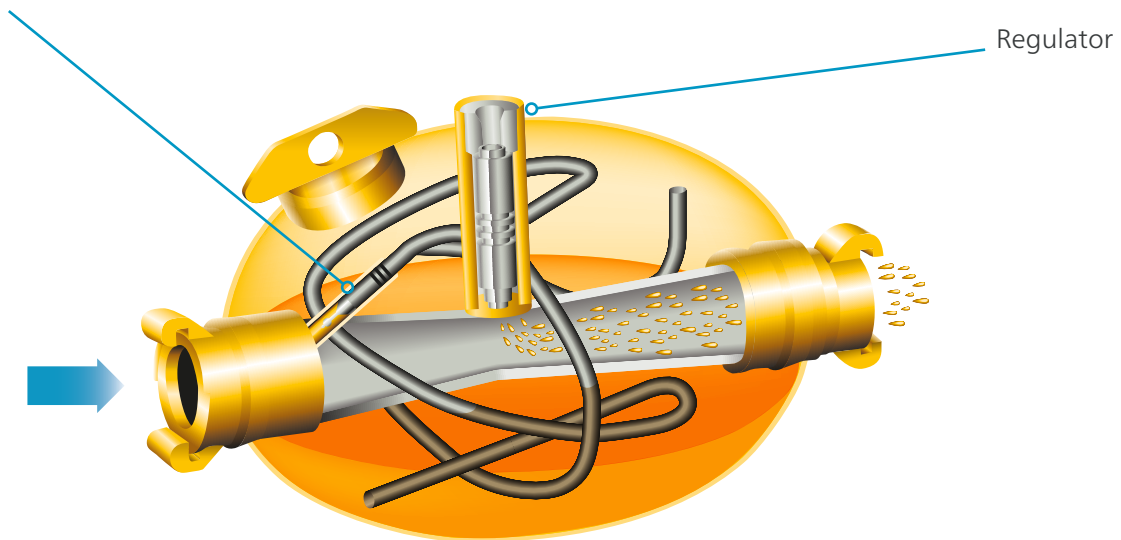

Atlas Copco’s lubricators use the ejector principle to create controlled lubrication. The pick-up is intricately bent to the assure oil supply regardless of the lubricator’s position.

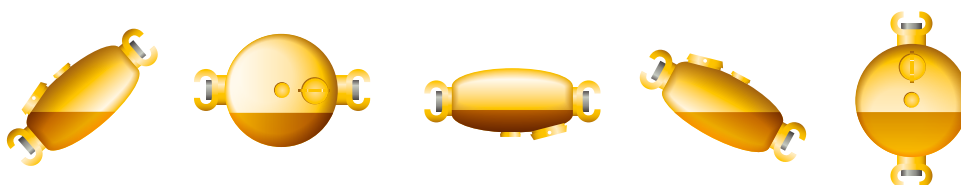

Pneumatic Breakers & Drillers Fluids

Air-Oil lubricants now biodegradable



The range of Air Oil lubricants have been developed for extremely demanding applications. High performance and bio-degradability are the key features of these products. The range consists of two types of lubricants, **Breaker and Hammer Air-Oil** and **Rock Drill Air-Oil**.

Breaker and Hammer Air-Oil is developed for Atlas Copco TEX pneumatic breakers and hammers. It prevents against freezing and corrosion.

Rock Drill Air-Oil is developed for Atlas Copco BBC, BBD and RH pneumatic rock drills. It is a heavy duty lubricant ensuring maximum life length and productivity of the rock drill.

Protect the environment, use Air-Oil Lubricants!

Biodegradability according to OECD 301

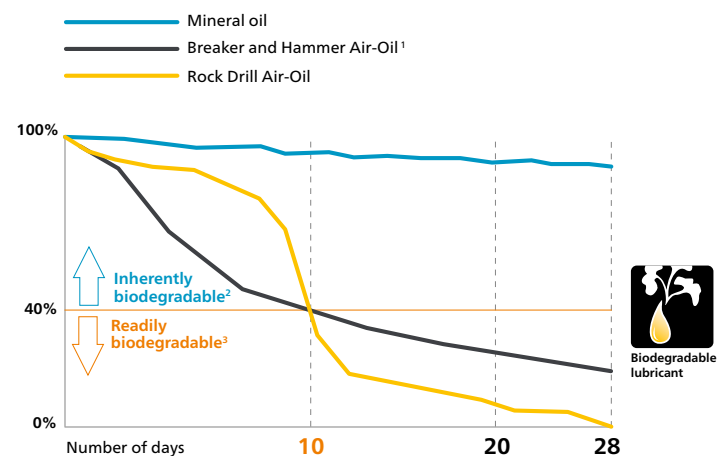

1) Inherently biodegradable in conformity with OECD 301B

2) Inherently biodegradable: Products with biodegradability between 20 – 60 % within 28 days

3) Readily biodegradable: Products with biodegradability over 60 % within 10 days

Rock Drill Air-Oil

All pneumatic tools require some oil in the airline to lubricate the inner moving parts and reduce the wear between them (cooling them and reducing the friction). Rotation units (in rock drills) without oil fail after short time.

Rock Drill Air-Oil machine reliability and service life by superior protection against machine wear and corrosion. Specially developed for Atlas Copco BBC, BBD and RH pneumatic Rock Drills.

Rock Drill Air-Oil

Product range

Features

Benefits

High film strength that withstands heavy loads and safely protects components

Improved machine reliability and service life. Safely protects components such as piston, cylinder, chuck drive, rifle-bar and ratchet wheel against wear and corrosion

Works throughout the temperature range -25 to +108°C/-13 to +226°F

Superior temperature range compared to other mineral oils. Adhesion and larger drop formation contribute to the very good lubricating properties

Readily biodegradable according to OECD301B. Based on > 90% renewable raw materials

Environmentally adapted. This means that the biodegradability is over 60% within 10 days.



- 0.4ml of oil per 1m³/min of air consumption of the rock drill
- Typically about 15 L tools per year for surface rock drills like RH and 50 to 70 L for underground rock drills like BBC and BBD

Description

Remarks

Part number

Description	Remarks	Part number
Rock Drill Air-Oil	1 l bottle (34 US fl oz)	8099 0201 01
	12 x 1 l bottles (34 US fl oz)	8099 0201 81
	4 l bottle (1.06 US gal)	8099 0201 04
	4 x 4 l cans (1.06 US gal)	8099 0201 84

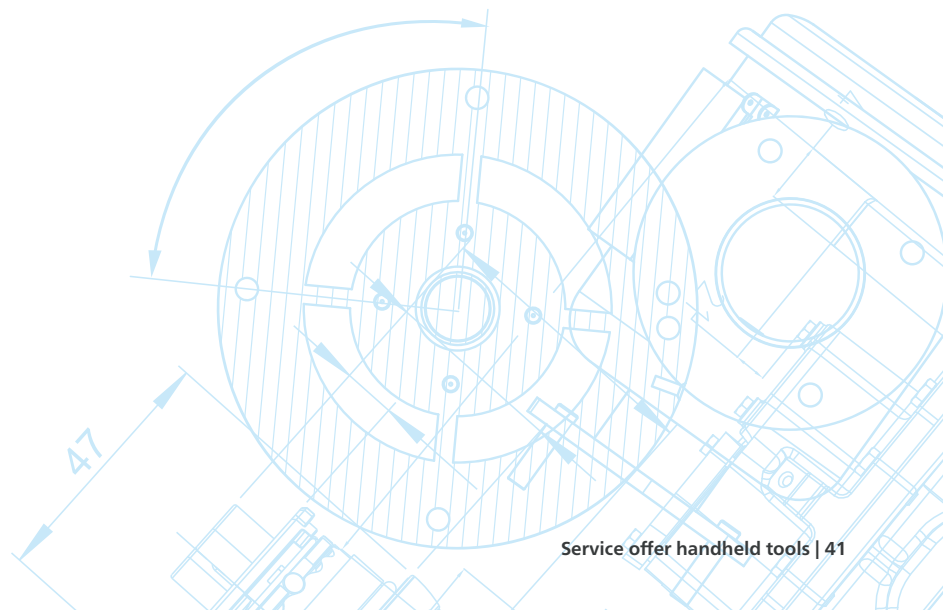

Breaker and Hammer Oil

All pneumatic tools require some oil in the airline to lubricate the inner moving parts and reduce the wear between them (cooling them and reducing the friction). Percussion units (breakers, hammers) without oil have a strong wear on piston and cylinder. In the past, decades ago, the compressors leaked so much oil that was enough for lubricate hammers and breakers. But that does not happen anymore.

Breaker & Hammer Air-Oil is a fully synthetic lubricant with excellent lubricating, rust preventing and de-icing properties, especially developed for TEX pneumatic breakers and hammers, and DIP & DOP pumps for a smooth continuous operation under extreme conditions.

Breaker & Hammer Air-Oil



- 0.25ml of oil per 1m³/min of air consumption of the machine
- Typically about 10 L tools per year for breakers and 5 l for pick hammers/RTEX

Product range

Features

Anti-ice properties thanks to glycol additive with outstanding operating temperature range from -30 to +50 °C/-22 to 122 °F

Anti corrosion protection

Readily biodegradable according to OECD301B

Benefits

Absorbs water condensate and prevents freezing. Specially suitable for silenced breakers and hammer where ice can build up in the silencer. Excellent to use in high humidity or low temperature climates

Absorbs condensed water, eliminating the need of a water separator: increases efficiency in the airline reducing pressure loses. Excellent lubricating properties for non rotating air tools such as breaker and hammers.

Environmentally adapted. This means that the biodegradability is over 60% within 10 days .

Syntetic biodegradable lubricant for hand held pneumatic breakers and hammers. Absorbs water and prevents icing.

Description	Oil volume		Weight	Part number
	l	gal	kg ¹⁾	
0.25 l bottle	0.2	0.05	0.3	8099 0202 40
1 l bottle	1	0.22	1.1	8099 0202 36
20 x 1 l bottles (pack)	20	4.4	22	8099 0202 81
5 l container	5	1.1	5.8	8099 0202 02
4 x 5 l containers (pack)	20	4.4	24	8099 0202 85

¹⁾ 1 kg = 2.2 lb

Pay for 0.8 l

Pay for 18 l

Service Offer For Hydraulic Tools





Discover the broad scope of Atlas Copco accessories available for our multifunctional hydraulic tools. Plug and Play, it's that easy. The tools will do the rest for you. Our accessories are designed especially for tough jobs where the endurance, strength and durability plays an important role. In such working conditions, you need a reliable partner providing you all these features to accomplish your tasks just in time. We offer peace of mind with our extensive accessories offer.

Hydraulic Accessories

Hydraulic hoses

	Description	Length		Diameter		Weight	Comments	Part number
		m	ft	mm	in	kg ¹⁾		
	Hydraulic twin-extension hose	7.0	23	12.5	½	8.3	Incl. ½ inch Flat-Face quick-release couplings	3371 8010 87
		12.0	39	12.5	½	13.3	Incl. ½ inch Flat-Face quick-release couplings	3371 8010 89
		7.0	23	12.5	½	8.0	Incl. ½ inch BSP female connection for direct mounting	3371 8010 82
	Double connection hoses	1.6	5	12.5	½	1.7	-	3371 8011 90

Hydraulic quick-release couplings

	Description	Length		Connection		Weight	Comments	Part number
		m	ft	mm	in	kg ¹⁾		
	Flat-Face quick-release coupling	70	2 ¾	12.5	½	0.2	Female	3371 8051 33
		70	2 ¾	10.0	¾	0.2	Female	3371 8051 37
	Flat-Face quick-release coupling	65	2 ½	12.5	½	0.2	Male	3371 8051 34
		65	2 ½	10.0	¾	0.2	Male	3371 8051 38

Hoses for hydraulic submersible pumps

	Description	Length		Connection		Weight	Comments	Part number
		m	ft	mm	in	kg ¹⁾		
	Hose for 2 inch water pump	10.0	33	50.8	2	3.4	Snap-lock quick-release coupling, female	3378 0021 00
	Hose for 3 inch trash pump	10.0	33	76.2	3	3.8	Snap-lock quick-release coupling, female	3378 0021 01

Diamond discs for 14 inch and 16 inch cut-off saw

	Description	Blade size		Arbor hole diameter		Weight	Comments	Part number
		m	ft	mm	in	kg ¹⁾		
	Concrete diamond disc	335	14	25.1	1	1.6	For wet and dry cutting. Cutting concrete and concrete reinforcement	3378 0050 57
		405	16	25.1	1	2.3	For wet and dry cutting. Cutting concrete and concrete reinforcement	3371 8097 27
	Asphalt diamond disc	335	14	25.1	1	1.6	For wet and dry cutting. Cutting asphalt	3378 0050 58
		405	16	25.1	1	2.6	For wet and dry cutting. Cutting asphalt	3371 8097 26

¹⁾ 1 kg = 2.2 lb

Post puller

	Description	Weight	Comments	Part number
		kg ¹⁾		
	LPP 10 HD Lever kit	10	Boost the pulling force by an extra 4 tons	3371 8101 48





Water kit for core drill and cut-off saw

	Description	Size (W x H x D)		Water volume		Weight	Comments	Part number
		mm	in	l	gal			
	Water kit with pressure tank	220 x 620 x 250	9 x 24 x 10	10	2.6	8	Water supply for LCD core-drill and LS cut-off saw	3371 8090 02

Cart for 14 inch and 16 inch cut-off saw



	Description	Weight	Comments	Part number
		kg ¹⁾		
	LSC cart for cut-off saw	25	incl. water kit	1809 0010 01

Diamond core bits (thread size 1 1/4 UNC)





	Description	Core bit size		Length		Weight	Comments	Part number
		mm	in	mm	in			
	Diamond core bit	Ø 62	Ø 2 7/16	450	18	1.7	Concrete, reinforced concrete and brickwork	3378 0050 61
		Ø 82	Ø 3 1/4	450	18	2.4	Concrete, reinforced concrete and brickwork	3378 0050 62
		Ø 102	Ø 4	450	18	3.2	Concrete, reinforced concrete and brickwork	3378 0050 63
		Ø 112	Ø 4 3/8	450	18	3.7	Concrete, reinforced concrete and brickwork	3378 0050 64
		Ø 132	Ø 5 1/4	450	18	4.6	Concrete, reinforced concrete and brickwork	3378 0050 65
		Ø 152	Ø 6	450	18	6.0	Concrete, reinforced concrete and brickwork	3378 0050 66
		Ø 162	Ø 6 3/8	450	18	6.3	Concrete, reinforced concrete and brickwork	3378 0050 67
		Ø 200	Ø 8	450	18	9.9	Concrete, reinforced concrete and brickwork	3378 0050 68
	Chuck kit for drilling	-	-	100	4	0.4	Chuck 1.5 - 16 mm (0.06 - v.xx in) Adaptor (1/2 in BSP male to 1/2" UNF male)	3371 8077 68
	Chuck	-	-	55	2.2	0.3	Chuck 1.5 - 16 mm (0.06 - x.xx in) 1/2" UNF female	3371 8077 66
	Adaptor (For Chuck)	-	-	45	1.8	0.1	Adapter (1/2" BSP male to 1/2" UNF male)	3371 8077 67
	Adaptor (Optional in USA and Canada)	-	-	45	1.8	0.1	Adaptor (1/2 in BSP male to 5/8" UNC male)	3371 8077 74
	Adapter (Standard)	-	-	45	1.8	0.1	Adapter (1/2" BSP male to 1 1/4" UNC male)	3378 5120 64

¹⁾ 1 kg = 2.2 lb

Adaptors for hydraulic LPD post driver

	Description	Adaptor size		Weight	Comments	Part number
		mm	in	kg ¹⁾		
	Adaptor square	□ 54	□ 2 1/8	2.0	-	3371 8060 32
	Adaptor universal (round / square)	63	2 1/2	1.6	Max. dimensions 102 x 70 mm (4 x 2 3/4 in)	3371 8060 33
	Adaptor round	Ø 96	Ø 3 3/4	1.4	-	3371 8060 34
-	C120 post driver kit	-	-	-	-	3371 8060 46
-	Round poles	64	2 1/2	-	-	3371 8060 47
-	Round poles	76	3	-	-	3371 8060 48
-	Round poles	89	3 1/2	-	-	3371 8060 49
-	Round poles	102	4	-	-	3371 8060 50
-	Round poles	127	5	-	-	3371 8060 51

Augers for handheld and rig-mounted posthole borer

	Description	Auger size		Length		Weight	Part number
		mm	in	mm	in	kg ¹⁾	
	Auger	Ø 90	Ø 3 1/2	870	34	7.0	3378 0050 45
		Ø 150	Ø 6	870	34	8.9	3378 0050 46
		Ø 200	Ø 8	870	34	10.5	3378 0050 44
		Ø 250	Ø 10	870	34	15.0	3378 0050 47
		Ø 280	Ø 11	870	34	17.2	3378 0050 49
		Ø 350	Ø 14	870	34	21.0	3378 0050 48
	Bit incl. bolts	Ø 90	Ø 3 1/2	-	-	0.2	3378 0999 28
		Ø 150	Ø 6	-	-	0.2	3378 0999 30
		Ø 200	Ø 8	-	-	0.3	3378 0999 31
		Ø 250	Ø 10	-	-	0.3	3378 0999 32
		Ø 280	Ø 11	-	-	0.4	3378 0999 33
		Ø 350	Ø 14	-	-	0.4	3378 0999 34
	Extension rod	-	-	500	20	5.0	3378 0050 55
	Tip for posthole borer universal	-	-	-	-	0.4	3378 0999 36

Service Tools

	Description	Pressure		Oil flow range		Weight	Comments	Part number
		bar	psi	l/min	gal/min	kg ¹⁾		
	Accumulator filling device complete	0 – 400	145 – 5720	-	-	1.6	Nitrogen charging and testing unit including tool 3371 8077 60	3371 8011 55

¹⁾ 1 kg = 2.2 lb

Hydraulic Power Pack Fluids



Atlas Copco Power Pack Bio-Oil is readily biodegradable hydraulic based on synthetic, quickly biodegradable ester and environmentally friendly combination of additives that exceeds the technical requirements according to ISO 15380:2011. It is environmentally friendly, biodegradable and non-hazardous to the water, reducing the impact in case of accidental spillage and makes it the perfect choice for your LP power pack.

Atlas Copco LP power packs work with normal mineral and synthetic oils (but not with water-based emulsions), but we recommend the use of biodegradable oil to protect the environment. LP power packs are supplied with biodegradable oil (synthetic), and hence a complete removal of the hydraulic circuit is needed if you still want to change to mineral. You cannot mix mineral and synthetic hydraulic oils.

Power Pack Bio-Oil

- Zinc-free hydraulic oil
- For temperatures from -30°C – +95°C
- For Atlas Copco's hydraulic power packs as well as all other hydraulic oil operations.

Features:

- Biodegradable
- Low sensitivity against temperature changes

Power pack Bio-Oil



- About 8 l/300 h
- Typically 8 to 10 l per year (one oil change including the oil in the hoses and tools)

Features

Reliable protection against wear, scuffing and corrosion

High viscosity, more insensitive to ambient temperature variations

Readily biodegradable

Description

4 litres

Benefits

Reduced maintenance costs

Optimized machine lifetime and wide temperature range from -15°C to +80°C/5 to 176 °f

Environmental friendly, reducing the impact of the environmental contamination in case of accidental spillage

Part number

3382 0700 86

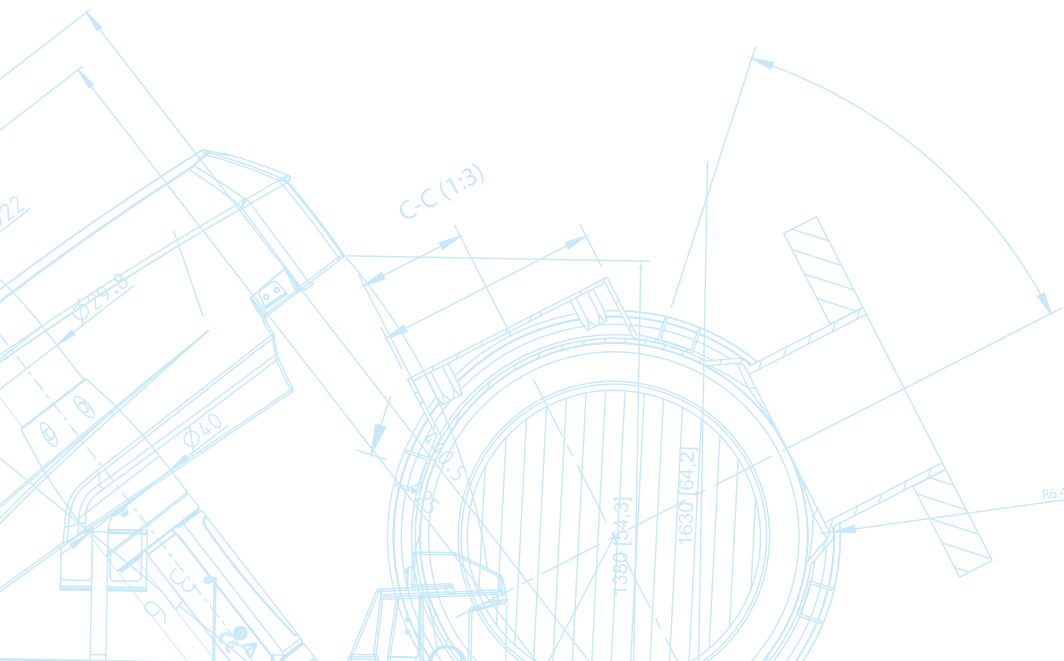

Service Offer For Motor Drills And Breakers



Atlas Copco offers you a comprehensive service package including everything you need throughout the life time of your product. From preventive maintenance, start-up kits to fluids and cosmetic kits, we provide you a seamless service experience whilst you enjoy working with your product. In the heat of your operation, time is precious, we therefore have a complete service offer to facilitate your job and eliminate time losses. Productivity is key in every operation and thus making us your reliable partner with our top quality and versatile service products.

Preventive maintenance kits

Designed to fit the recommended service operations for daily maintenance on-site and workshop after 6 months/250 hours and 12 months/500 hours in the Cobra PRO and TT, and the small and large service in the Cobra Combi.

Preventive maintenance kits	Product range		
	Product	Use	
	Engine Maintenance Kits	Package with air filters and spark plugs, for the normal period between workshop service. Aimed for self-maintenance and suitable to carry on with the Cobra	
	Workshop Service Kits	Kits for the periodic workshop service. Offered as a basic one, plus on optional one for yearly maintenance.	
	Description	Remarks	Part number
	6 Month Service Kit Cobra PRO & TT	For all PRO and TT models	9234 0211 56

Service kits

Service kits are designed for the most common repair operations in the Cobra range, apart of the general maintenance operations.

Repair kits	Product range		
	Product	Use	
	Carburetor repair kit	To repair carburetor, often affected by improper lubrication	
	Hammer cylinder piston kit	To repair the hammer cylinder piston, subject to wear and failure in the long term after impacting in the working tool time after time	
	Seal kit	For complete overhauling, replacement of all gasket and seals in the machine	
	Description	Remarks	Part number
	Seal kit	Cobra Combi	9234 0009 22
	Carburetor repair kit	Cobra PRO, TT, Combi, all models	9234 0009 12
	Seal kit	Cobra PRO and TT, all models	9234 0006 91
	Hammer cylinder piston kit Cobra PRO	Cobra PRO, all models	9234 0039 00
Hammer cylinder piston kit Cobra TT	Cobra TT, all models	9234 0039 00	

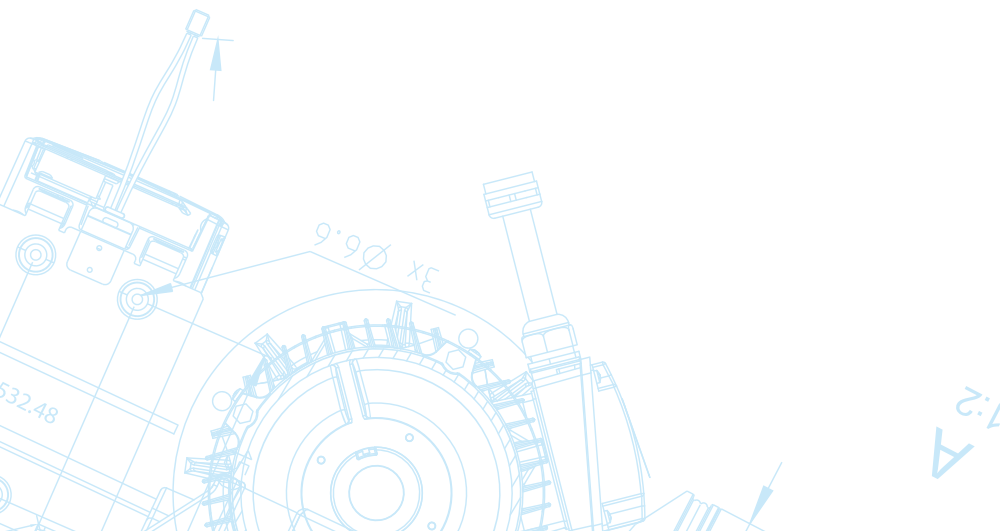

Start-up kits

Start-Up Kit has a set of consumables and maintenance parts to keep Cobras up and running for the initial operation until to the first scheduled maintenance interval, after 250 hours (typically half year time under normal usage). With the Start-Up Kit, just need to add the corresponding working tools to keep Cobra up and running initially.

Content:

- Cobra & Compactor Impact-Oil 1 l / 34 US fl oz bottles
- Cobra Mix-Oil in 4 boxes of 12 x 0.1 l / 3.4 US fl oz bottles
- One engine maintenance kit (including air filters and spark plugs)

Start-up kits	Product range	
	Features	Benefits
	<p>The Start-Up Kit includes all parts and consumables needed to keep your machine in production for approximately 250 hours (six months of normal operation), until the first workshop maintenance is due</p>	<ul style="list-style-type: none"> • Work without interruptions with the most common items readily available for the scheduled maintenance, increasing uptime • Use of Atlas Copco's genuine consumables and parts extends the lifetime of all major components, saving time and money • The Start-Up Kits meet Atlas Copco's warranty requirements
	<p>One Start-Up Kit per machine model available and orderable using a single reference</p>	<p>Easy to manage, saving time and administrative costs. One order includes all articles needed for a new Cobra</p>
	<p>The Start-Up Kit is delivered in an all-in-one box</p>	<p>All articles for the maintenance of your equipment are in one place. Saving on storage and transport costs</p>
	<p>Kits are attractively priced, with a lower cost than purchasing items individually</p>	<p>Cost-effective solution that keeps your maintenance budget low</p>
	Description	Remarks
<p>Start-Up Kit Cobra PRO & TT</p>	<p>Including Impact-Oil, Mix-Oil (0.1L bottles) and Engine Maintenance Kit</p>	<p>9234 0211 70</p>

Motor Drills And Breakers Fluids

Cobra mix oil

Outstanding piston cleanliness and life time

Your Cobra's heart is a specifically designed two-stroke engine. To get the most out of it, you should use self-mixing Cobra Mix-Oil, which is thoroughly tested to fulfil the high demands of the oil mix. Cobra MIX-OIL is a semi-synthetic 2-stroke engine oil. The product reduces smoke in the exhaust gas and provides a solid protection for the engine.

Cobra Mix-Oil is mixed with fuel in accordance with the model specification, typically in a 2% mix for Cobras and 5% in older Pionjar models.

Cobra mix-oil	Product range		
	Features	Benefits	
 <ul style="list-style-type: none"> • Approx. 20 ml/h • Typically 5 l per year and machine for maintenance works and 8 to 10 l for continued works like tie tamping 	Extremely low smoke and odor from the exhaust	Increases reliability and reduces maintenance cost by keeping the exhaust system clean	
	Partially biodegradable / immobile and non-toxic	Extends lifetime and reduces maintenance cost, keeping the engine and spark plugs clean	
	Self-mixing. High fluidity and miscibility at very low temperatures	Extends lifetime by keeping the engine well lubricated at both high and extremely low temperatures	
	Meets the latest international specifications JASO FD/ ISO-L-EGD	Highest international quality standards set easy to compare Cobra Mix-Oil's outstanding properties, especially for piston cleanliness and detergent effect	
	Description	Remarks	Part number
	Cobra Mix-OIL	12 x 100 ml bottles (3.4 US fl oz). For mixing on 5 l (1.32 US gal) petrol can	9238 2743 40
		1 l bottle (34 US fl oz)	9238 2743 50
		12 x 1 l bottles (34 US fl oz)	9234 0014 06

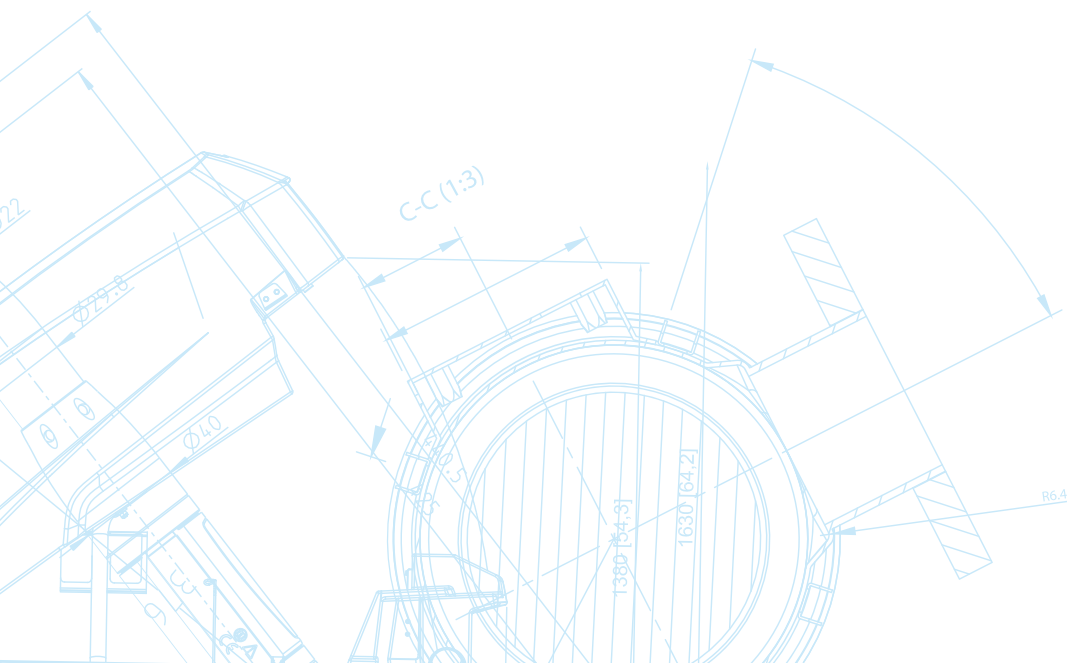

Cobra Impact-Oil

Cobra Impact-Oil is a premium mineral oil for optimal performance and protection of the transmission and impact mechanism in Cobra breakers. This oil is formulated from a highly refined mineral oil and an advanced additive system. It features excellent high temperature viscosity retention over extended service periods, performing well under the high loads of Cobra machines.

Each oil bath has a capacity of 100 ml/3.4 US fl oz. They are checked periodically (at least monthly) and refilled when the oil level drops, and they are replaced when a general overhaul is required (after 250 hours or 6 months). Main oil consumption comes from impact mechanism (to be checked weekly), and it is 0.005 l/h (0.17 US fl oz/h).

Cobra Impact-oil		Product range	
		Features	Benefits
 <ul style="list-style-type: none"> • 5 ml/h replenishment + 100ml during change each 250 hours (workshop maintenance) • Typically 1.5 l per year and machine for maintenance works and 2 to 3 l for continued works like tie tamping 	Heavy-duty lubricant with high oxidation and thermal degradation stability	Suitable for all weather conditions and not affected by prolonged storage times of your machine	
	Improved cleanliness under the most severe conditions	Ensures your equipment will run smoothly and reliably	
	Superb anti-wear and corrosion protection and extremely high oxidation stability	Optimizes your machine lifetime, reducing the risk of scoring and abrasion	
Description	Remarks	Part number	
Cobra Impact-OIL	1 l bottle (34 US fl oz)	9234 0012 03	
	20 x 1 l bottles (34 US fl oz)	9234 0014 05	

Accessories for motordrills and breakers

Accessories	Description	Comment	Part number
	2-stroke oil, 1 l (0.22 gal)	Engine oil, fully synthetic and biodegradable	9238 2743 50
	2-stroke oil, 12 x 1 l (12 x 0.22 gal) Pay for 10 l	Box of 12. Engine oil, fully synthetic and biodegradable	9234 0014 06
	NEW Cobra & Compactor Impact-Oil, 1 l (0.22 gal)	Lubricant for impact and transmission unit for Cobra MK1 / TT / AWD	9234 0012 03
	Cobra & Compactor Impact-Oil, 20 x 1 l (20 x 0.22 gal) Pay for 18 l	Box of 20. Lubricant for impact and transmission unit for Cobra MK1 / TT /AWD	9234 0014 05
	Trolley	for Cobra / Cobra TT	9234 0006 54
	Carrying harness Spare parts list Cobra 9800 0655 01	-	9238 2814 10
	Guide roller Spare parts list Cobra 9800 0655 01	for Cobra Combi / Cobra Standard	9234 0009 38
	Tool bag	including: cleaning needle, template 22 x 108 mm (7/8 x 4 1/4 in), grinding template, socket wrench, oil measure, starter rope and spark plug	-
	Machine box Spare parts list Cobra 9800 0655 01	for Cobra Standard / Pionjär	9238 2713 90
	Machine box	for Cobra / Cobra TT	-
Tachometer	-	-	

Cosmetic service kits

Cosmetic service kits	Product range		
	Features	Benefits	
	All-in-one-box. One reference number speeds up delivery. Includes six month and extended service kit, covers and labels	Easy to obtain: Service Kits are readily available	
	Price for kits are set to approximately 20% of the price of a new breaker	Attractive investment, just slightly above complete overhaul, that maximizes value of the machine bringing it back to like-new condition	
	Description	Remarks	Part number
	Cosmetic Kit for Cobra	Including six month and extended service kits, plastic covers and labels. Tool chuck not included: added if needed the corresponding Tool Chuck kit	9234 0211 61
	Wear Kit for Tool Chuck Cobra PRO & TT	For Tool Chuck 32x160	9234 0211 60
		For Tool Chuck 32x152	9234 0211 62
		For Tool Chuck 28x160	9234 0211 63
For Tool Chuck 28x152		9234 0211 64	
For Tool Chuck 25x108		9234 0211 65	

